

indice/index

INTRODUZIONE/Introduction	04	mensola MISURA/MISURA shelf	383
PIATTI DOCCIA H3 shower trays H3		HANG&STAND	391
UNIKO	27	MOBILI E SPECCHI furnitures and mirrors	399
PURO	39	NATIVO	413
RELAX	43	FLEUR	419
PRUA	47	POOL	427
TULIP	69	GRAAL	433
CLAS+	105	TANDEM	441
NUVOLA	131	CIVITA	447
THIN	173	NOOK	455
COMODA	195	PIATTI DOCCIA shower trays	
VERA	209	FERDY H6	461
GLAZE	223	SOLUTION H3	467
CULT	239	RUBINETTERIA LINEA taps "LINEA"	471
PRATICA	249		
CHARME	263		
VICTORIAN STYLE	287		
ELEGANCE	313		
CONSOLLE SIZE	337		
CONSOLLE SLIM	345		
LAVABI ARREDO/washbasins	355		



AZZURRA Sanitari in Ceramica nasce nel 1985 a Civita Castellana. Diventa subito una delle realtà più produttive del distretto della Ceramica Sanitaria, che inizia in quegli anni, a delinearci nella zona e che mantiene tutt'oggi un ruolo centrale nella storia dell'arredo bagno. Si mostra fin dalle origini come una solida realtà produttiva capace di rispondere alle esigenze di un settore in continuo mutamento, proponendo soluzioni efficaci e sempre attuali, capaci di anticipare tendenze ed evoluzioni del mercato. Oggi l'azienda è una piattaforma che conta circa 130 dipendenti con una superficie di 30.000 m² e con una produzione di circa 300.000 pezzi l'anno, distribuiti non solo in Italia ma esportati in tutto il mondo. Dall'Europa ai vicini paesi extra CEE, dalla Russia all'Australia e all'America. La superficie produttiva è stata recentemente ampliata con una nuova area di 6000 m², già operativa, che ospita macchinari di ultima generazione: 2 apparecchiature di colaggio, 2 forni intermittenti, 5 cabine, 1 macchina rettificatrice e nuovi banchi per il test sulla qualità del prodotto finito.

Amore e passione per la materia e per le sue forme, ricerca al servizio dell'innovazione, manualità ed esperienza frutto di una tradizione trentennale nel settore della ceramica ma anche proiezione verso il futuro, per anticipare i nuovi bisogni dell'uomo contemporaneo e migliorare la sua qualità di vita: è questa la mission dell'azienda.

THE COMPANY. Azzurra Sanitari was born in 1985 in Civita Castellana. It immediately became one of the most productive reality in the sanitary ceramic district, playing still today a central role in the bathroom history. Since the beginning the strong production ability is inclined to meet the needs of the sector which is always changing, always proposing efficient and modern solutions, able to anticipate the trend of the market. Nowadays the company is a platform with around 130 skilled workers with a 30.000 sqm surface and a 300.000 pieces production per year, distributed all around the world. From Europe to the closest extra CEE countries, till Russia, Australia and America. The production surface has been recently extended with a new 6000 sqm area, already serviceable, equipped with high technology machines: 2 casting device, 2 intermittent kilns, 5 cabins, 1 grinding machine and new desks for quality control and tests of the end product.

Love and passion for the matter and its shapes. Research for innovation, manual skill and experience are the result of a thirty-year tradition in the field of ceramic but also projection into the future, to anticipate the new contemporary man needs' and improve his quality of life: this is the Mission of the company.



CULTURA e ANIMA

Amore e passione per la materia e per le sue forme, genialità al servizio dell'innovazione, manualità ed esperienza trentennale delle maestranze, proiezione verso il futuro nel segno del design e della qualità, ricerca continua sui materiali e sulle linee.

Questo per AZZURRA è CULTURA.

Amore e passione per le persone, attenzione alle richieste di chi con il suo lavoro fa crescere l'azienda, rapporti familiari con gli operai e gli impiegati, sempre maggiore attenzione alla relazione con il cliente.

Questo per AZZURRA è ANIMA.

Il presente in AZZURRA è denso di questi due elementi. Il futuro con AZZURRA è il solo modo di dividerli.

CULTURE and SOUL

Love and passion for matter and its forms; brilliance in the service of innovation; craftsmanship and workers with over thirty years of experience; projection towards the future distinguished by design and quality; continuous research on materials and lines.

This is AZZURRA's CULTURE.

Love and passion for people; attention to the demands of those who with their work contribute to the business growing; family relationships with workers and employees; more and more customer focused.

This is AZZURRA's SOUL.

AZZURRA's present is full of these two elements. AZZURRA's future is the only way to share them.



Alla scoperta del Made in Italy...
Discovering the Made in Italy...

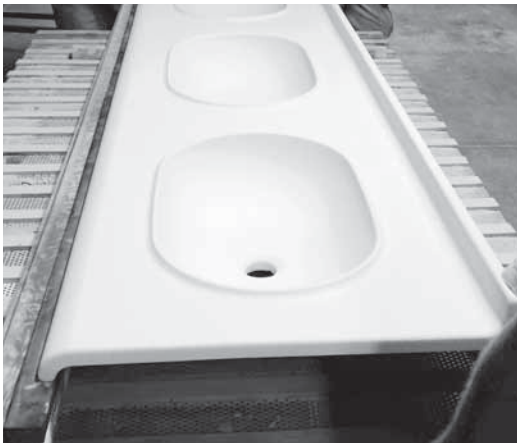
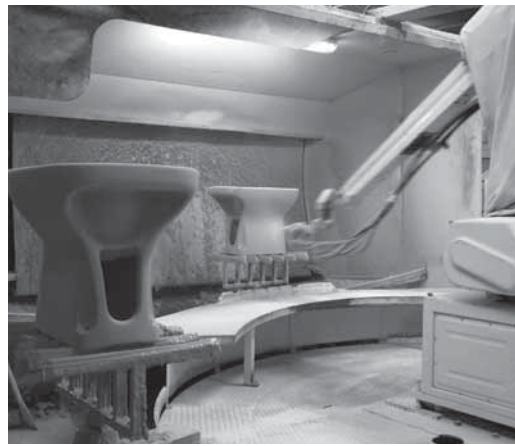

showroom.

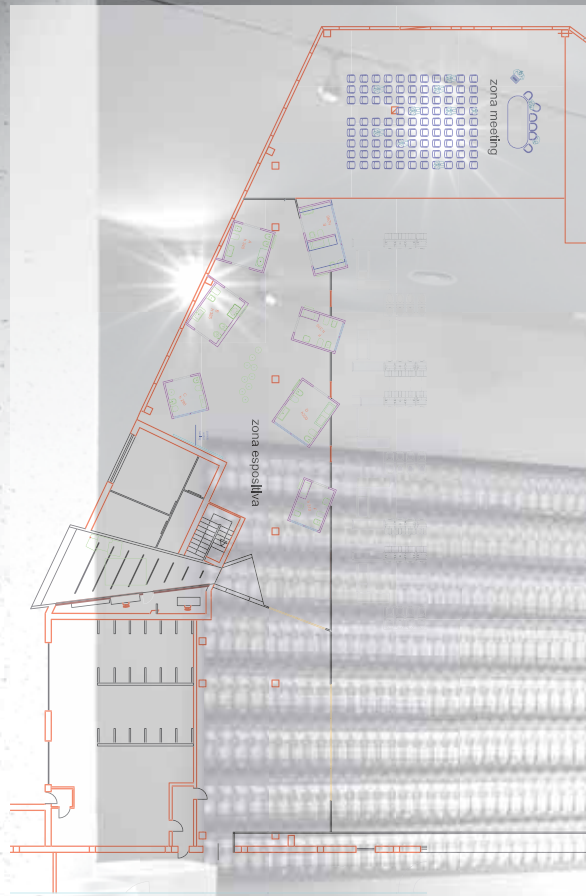

AZZURRA.nuova sede

Chi incontra AZZURRA incontra un team che lavora da quasi trent'anni per garantire al cliente un'offerta di prodotti e servizi straordinaria. Chi incontra gli uomini e le donne di Azzurra incontra storie di passioni per il prodotto, per il design e per la qualità, incontra la cultura e l'anima dell'azienda. Il luogo privilegiato che AZZURRA ha scelto per farsi conoscere dai propri clienti è il nuovo showroom aziendale, inaugurato nel 2013. Lo showroom di circa 1500 metri quadrati ospita tutte le Collezioni e le novità di AZZURRA ed è inserito all'interno del Museo della produzione ceramica aziendale, una parte dello stabilimento produttivo dove oggi si possono visionare i macchinari che hanno fatto la storia dell'azienda e al contempo si può ammirare la lavorazione totalmente manuale dei Pezzi Speciali. Una sala conferenze e un lounge bar completano l'accogliente showroom che offre la massima ospitalità.

AZZURRA.the new corporate headquarters

Those who meet AZZURRA meets a team that has been working for almost thirty years to provide customers a wide range of products and outstanding services. Those who meet Azzurra men and women meet stories of passion for the product, for design and quality, meet the culture and the soul of the company. The privileged place that AZZURRA has chosen to be known by its customers is the new company showroom, which opened in 2013. The showroom of about 1500 square meters hosts all AZZURRA collections and range and is inside the Museum of the company ceramic production, a part of the factory where today you can see the machines that have made the history of the company and at the same time you can see the full manual processing of Special Pieces. A conference room and a cozy lounge bar complete the showroom that offers the utmost hospitality.

lounge bar.



sala conferenze.
conference hall.





Le sfide già vinte
challenges already won

Water Saving

Il bagno su misura
the custom made bathroom

30 anni di cultura d'impresa

abbiamo deciso di farvi risparmiare. l'acqua
we have decided to save. Water

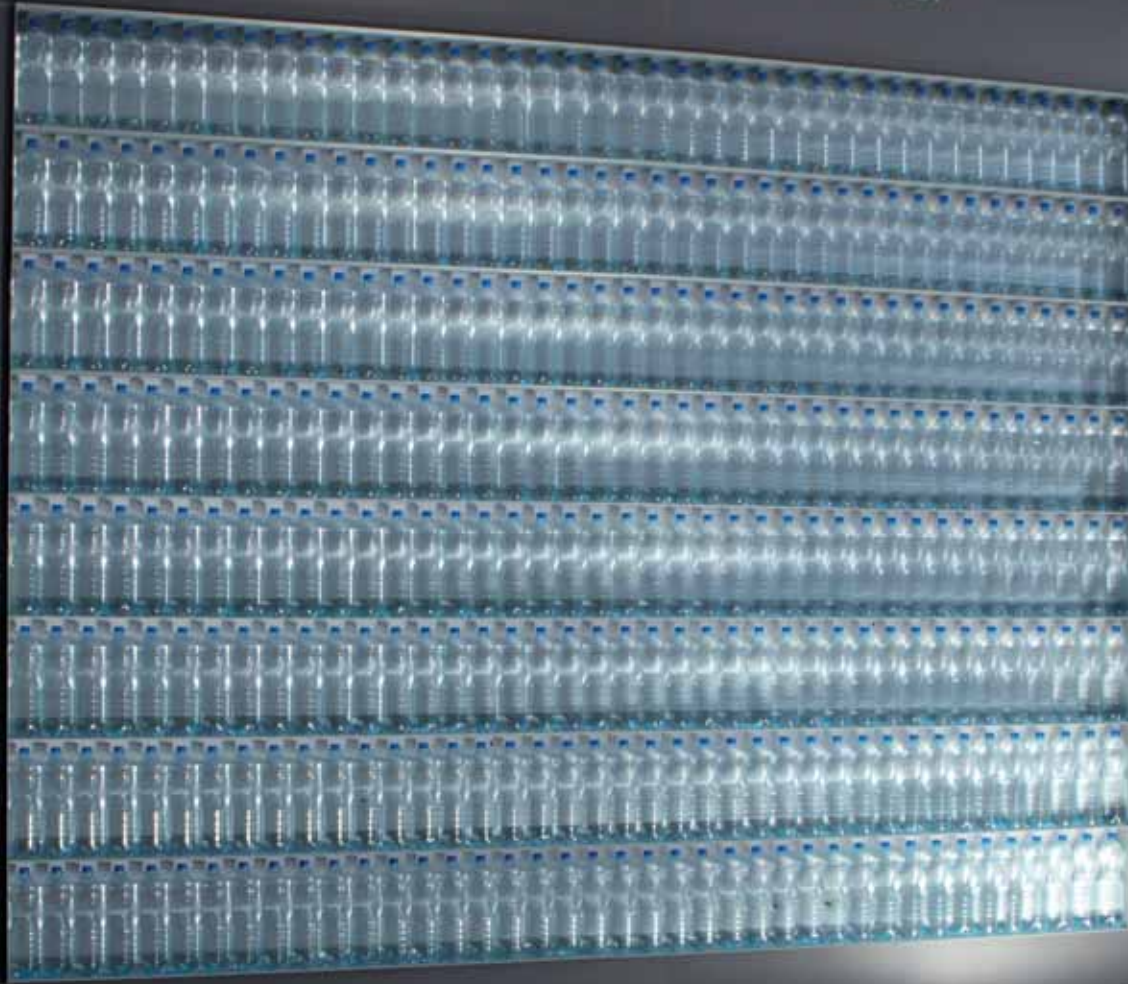

31.000 litri d'acqua in un anno.
600 litri d'acqua in una settimana.
85 litri d'acqua in un giorno.
Tanto può risparmiare ogni famiglia
di 4 persone che usa
i sanitari AZZURRA Water Saving
invece di quelli tradizionali a 9 litri.
I sanitari Water Saving sono fatti per
risparmiare fino al 70% di acqua
ad ogni scarico grazie all'abbinamento
con le cassette di scarico e con la
placca monoflusso.
Un sistema brevettato.
Un primato mondiale firmato AZZURRA.

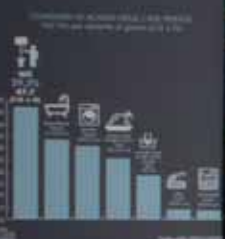

31.000 liters of water a year.
600 liters of water in a week.
85 liters of water in a day.
Such is the amount of water each family
of 4 people can save when using
the AZZURRA Water Saving sanitary
wares instead of the traditional 9 liter ones.
The Water Saving sanitary wares
are made to save up to 70% of water
on each flush thanks to the
combination with the flushing system
and with the monoflow plate.
A patented system.
A world record signed AZZURRA.

AZZURRA ha deciso di farvi risparmiare. l'acqua
AZZURRA has decided to make you save. water

31.000 litri d'acqua in un anno.
600 litri d'acqua in una settimana.
85 litri d'acqua in un giorno.
Tanto può risparmiare ogni famiglia di 4 persone
che usa i sanitari AZZURRA WATER SAVING invece
di quelli tradizionali a 9 litri.
I sanitari Water Saving sono fatti per
risparmiare fino al 70% di acqua
ad ogni scarico grazie all'abbinamento con le cas-
sette di scarico e con la
placca monoflusso.
Un sistema brevettato.
Un primato mondiale firmato AZZURRA.

31.000 liters of water a year.
600 liters of water in a week.
85 liters of water in a day.
Such is the amount of water each family of 4
people can save when using the
AZZURRA WATER SAVING sanitary wares instead
of the traditional 9 liters ones.
The Water Saving sanitary wares are made to
save, **up to 70% of water** on each flush
thanks to the combination with the flushing cistern
and with the mono-flow plate.
A patented system.
A world record signed AZZURRA.

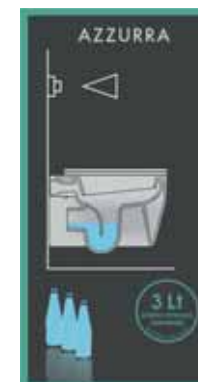

3 Lt
 scarico d'acqua
 brevettato
 WATER SAVING

placca
 monoflusso
 single flush



cassette
 scarico
 built-in
 cistern



sanitari
 wcs



= -70%
 scarico d'acqua



In un mondo in cui sempre più si parla di efficienza energetica degli edifici, Azzurra è la prima azienda ad aver brevettato sanitari in grado di utilizzare soltanto **3 litri d'acqua ad ogni scarico.**

In a world where energy efficiency in buildings has become dramatically important, Azzurra is the first company to patent sanitary wares able to flush with just **3 liters of water on every flush.**

AZZURRA

Il bagno su misura
the custom made bathroom



Alta sartorialità italiana
applicata alla ceramica

Italian haute couture
now applied to ceramic

TAGLIO SU MISURA AL CM
per **PIATTO DOCCIA uniko**
in ceramica h 3 cm
custom made cut to
centimeter for **uniko** ceramic
shower tray h 3 cm



Per il piatto doccia **uniko** AZZURRA ha depositato **tre brevetti** per la personalizzazione delle misure, per lo spessore di 3 centimetri e per l'antiscivolo Cortecceia. Inoltre ha una **certificazione dell'Università di Modena e Reggio Emilia** per NOBACTER 05, **sistema antibatterico e antifungo**. AZZURRA has obtained **three patents** for its Uniko shower tray; for the possibility to customize its size, for its 3 cm thickness and for the no-slip feature of the Cortecceia finish. Furthermore, Uniko has been **certified by the University of Modena and Reggio Emilia** for its **antifungal and antibacterial system**, NOBACTER 05.



UNIKO è disponibile tagliato al centimetro con misure da 60 a 200cm.
UNIKO is available in bespoken sizes in format ranging from 60 to 200 cm.

CONSOLLE SIZE

con taglio su misura al cm
CONSOLLE SIZE
custom made cut to
the centimeter

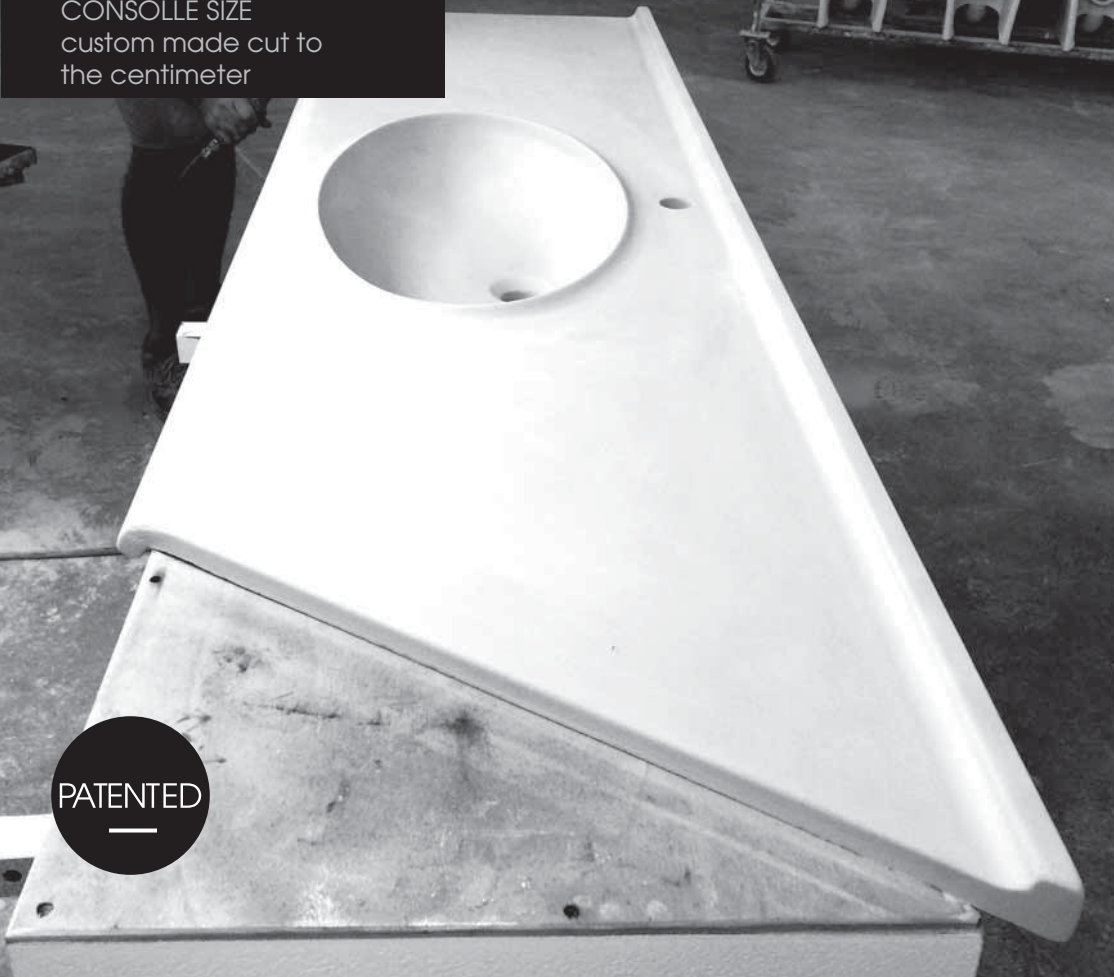

PATENTED

H 2 cm



CONSOLLE SIZE con taglio in diagonale su misura al cm.
CONSOLLE SIZE custom made diagonal cut to the centimeter

Mensola MISURA

in ceramica con taglio al cm
MISURA ceramic shelf
custom made cut to
the centimeter



mensola MISURA con taglio in diagonale su misura al cm.
MISURA shelf custom made diagonal cut to the centimeter

UNIKO H3
su misura in ceramica / *tailored in ceramic*

design: OFFICINA AZZURRA

photographer: Studio21



COLORS1250° FOR UNIKO



La ceramica come una pagina bianca da vestire con colori che appartengono al nostro vissuto e che parlano di noi. È questo il valore di Colors1250° for uniko: un mix di elegante matericità ed estetica abbinate ad un prodotto altamente tecnologico.

Per il piatto doccia **uniko AZZURRA ha depositato tre brevetti** per la personalizzazione delle misure, per lo spessore di 3 centimetri e per l'antiscivolo Corteccia. Inoltre ha una **certificazione dell'Università di Modena e Reggio Emilia** per NOBACTER 05, **sistema antibatterico e antifungo**.

Ceramics is seen as a blank page to paint in colours that belong to our experiences and say something about our lives. This is the main feature of Colors1250° for uniko: a mix of elegant material and aesthetics combined with a high-tech product.

AZZURRA has obtained three patents for its **Uniko** shower tray; for the possibility to customize its size, for its 3 cm thickness and for the no-slip feature of the Corteccia finishing. Furthermore, Uniko has been **certified by the University of Modena and Reggio Emilia** for its **antifungal and antibacterial system**, NOBACTER 05.

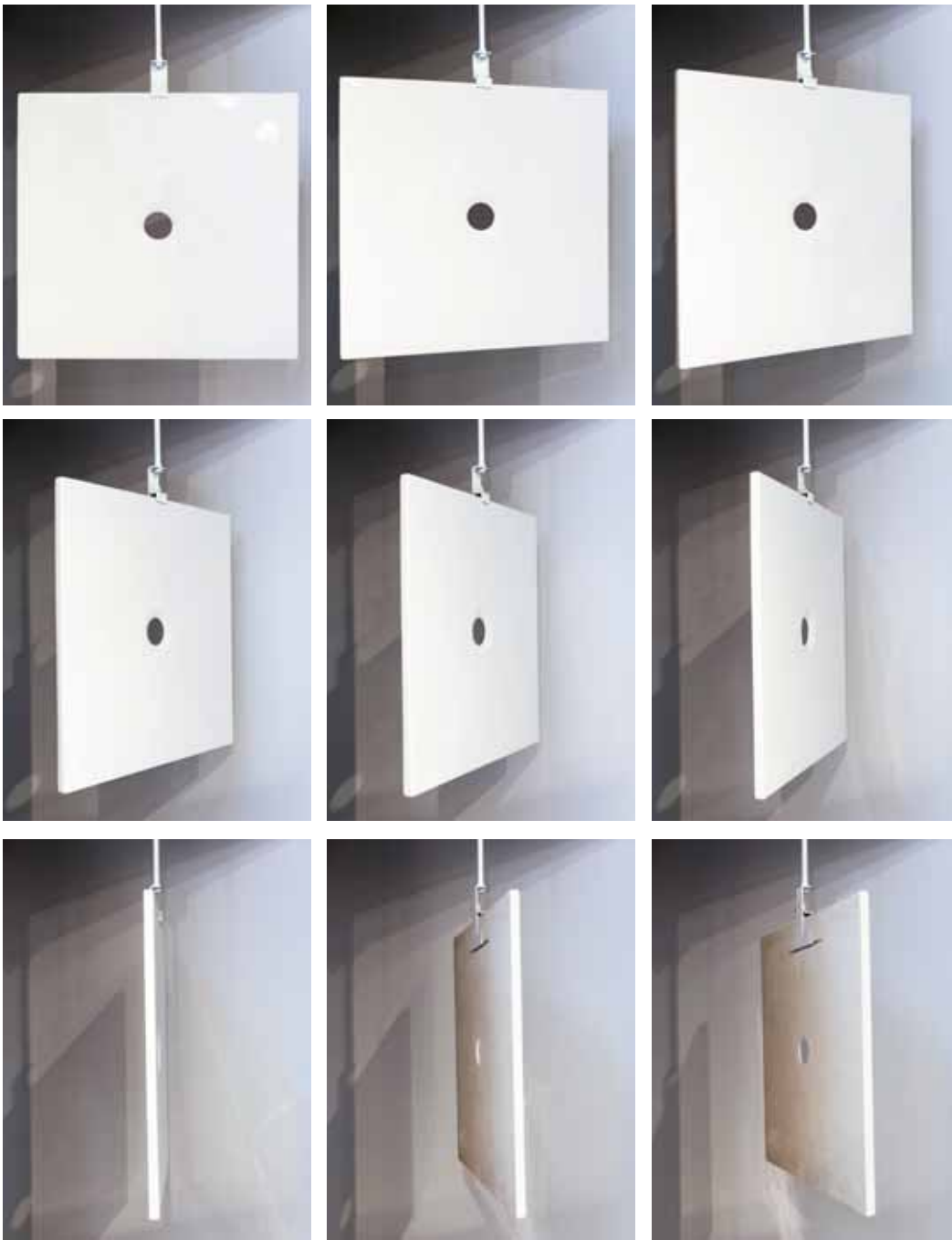

piatto doccia 100x100 H3
H3 100x100 shower tray

piatti doccia uniKo H3 uniKo H3 shower trays

- | | |
|-----|--|
| 01. | 80x65 UN 80/65
80x70 UN 80/70
80x80 UN 80/80 |
| 02. | 90x65 UN 90/65
90x70 UN 90/70
90x80 UN 90/80
90x90 UN 90/90 |
| 03. | 100x65 UN 100/65
100x70 UN 100/70
100x80 UN 100/80
100x90 UN 100/90
100x100 UN 100/100 |
| 04. | 120x65 UN 120/65
120x70 UN 120/70
120x80 UN 120/80
120x90 UN 120/90
120x100 UN 120/100 |
| 05. | 140x70 UN 140/70
140x80 UN 140/80
140x90 UN 140/90
140x100 UN 140/100 |
| 06. | 160x70 UN 160/70
160x80 UN 160/80
160x90 UN 160/90
160x100 UN 160/100 |
| 07. | 170x70 UN 170/70
170x80 UN 170/80
170x90 UN 170/90
170x100 UN 170/100 |
| 08. | 180x70 UN 180/70
180x80 UN 180/80
180x90 UN 180/90
180x100 UN 180/100 |
| 09. | 190x70 UN 190/70
190x80 UN 190/80
190x90 UN 190/90
190x100 UN 190/100 |
| 10. | 200x70 UN 200/70
200x80 UN 200/80
200x90 UN 200/90
200x100 UN 200/100 |

COLORS 1250°



CORTECCIA

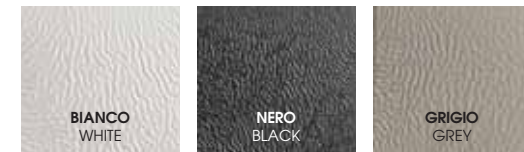

Trattamento antibatterico - antifungo applicabile su tutti i prodotti in ceramica e coprivasi.
The antibacterial - antifungal treatment can be applied to all ceramic products and cover-seats.

Disponibile in 41 misure standard, 9 colorazioni diverse e 3 finiture Corteccia antiscivolo.
Available in 41 standard sizes, 9 different colors and 3 Anti-slip Corteccia finishings.



piatto doccia uniKo H3
uniKo H3 shower tray

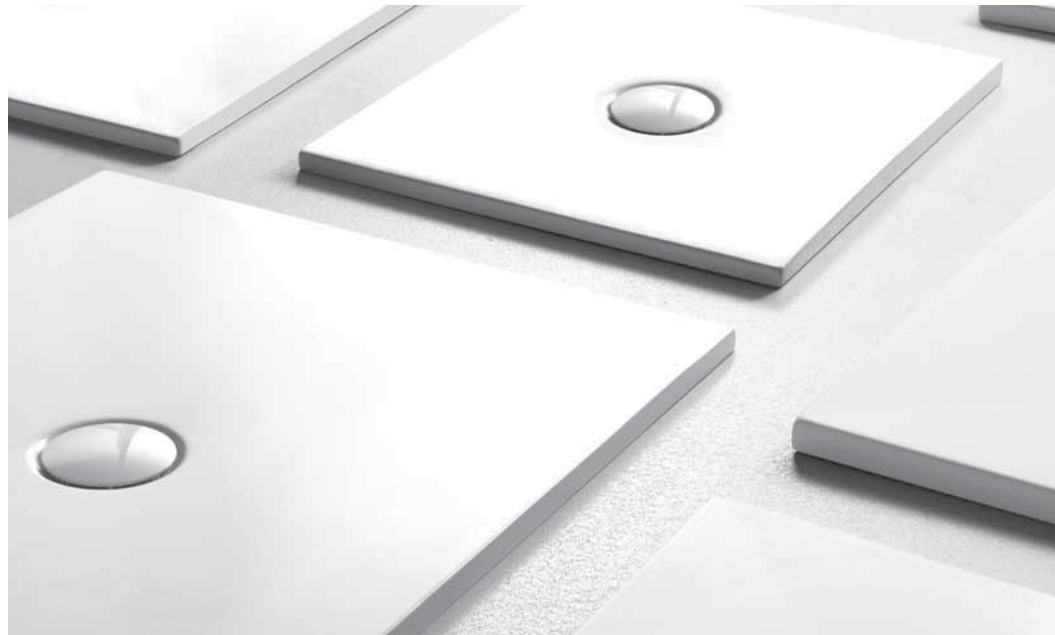



uniKo il primo piatto doccia su misura
in ceramica h3 cm
uniKo the first tailored ceramic shower tray h3 cm

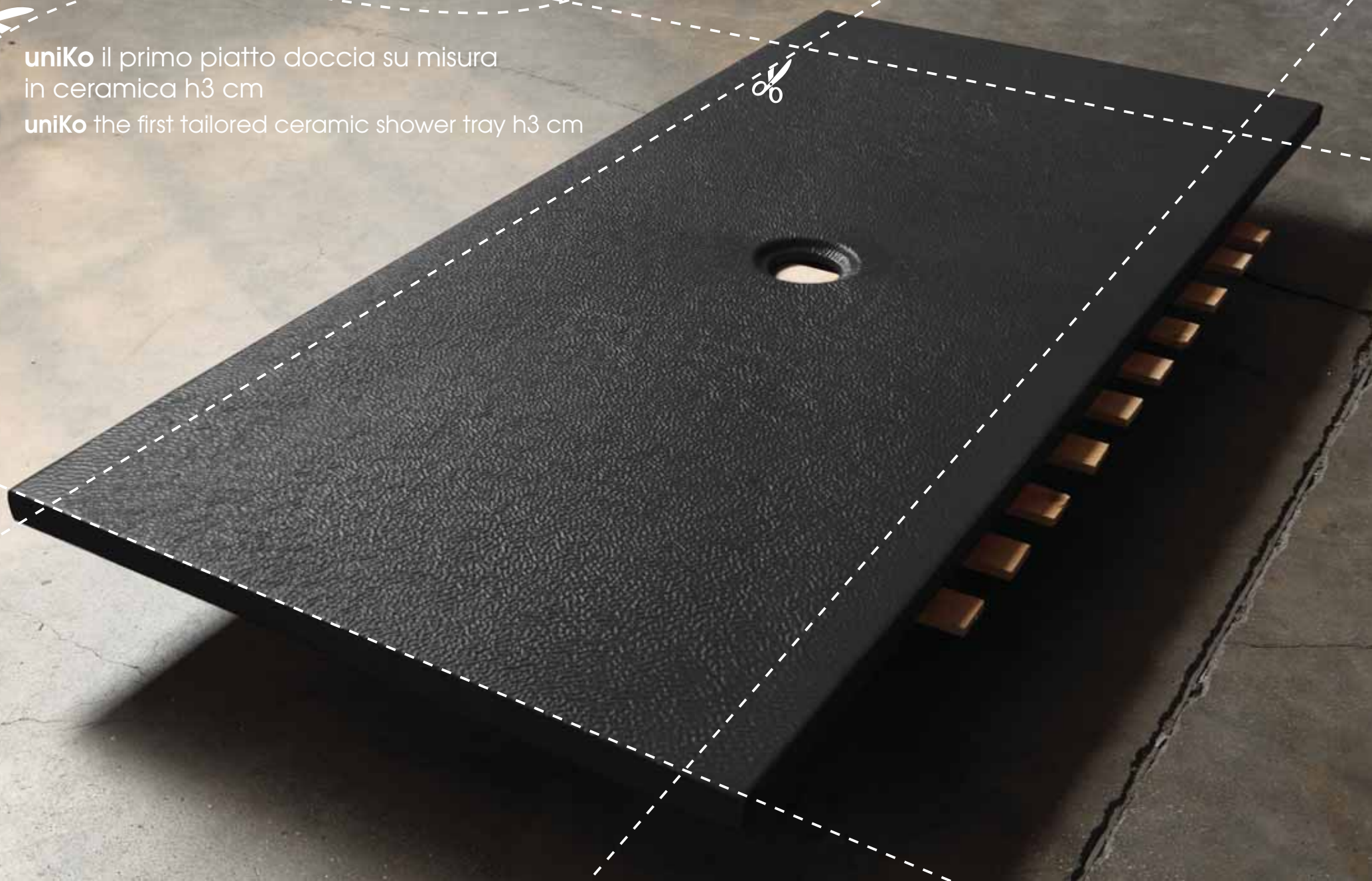

Per il piatto doccia **uniKo** AZZURRA ha depositato tre brevetti per la personalizzazione delle misure, per lo spessore di 3 centimetri e per l'antiscivolo Corteccia. Inoltre ha una certificazione dell'Università di Modena e Reggio Emilia per NOBACTER 05, sistema antibatterico e antifungo.

AZZURRA has obtained three patents for its **Uniko** shower tray; for the possibility to customize its size, for its 3 cm thickness and for the no-slip feature of the Corteccia finishing. Furthermore, Uniko has been certified by the University of Modena and Reggio Emilia for its antifungal and antibacterial system, NOBACTER 05.

uniKo 2mt

Uniko: il primo piatto doccia in CERAMICA su misura spesso solo 3 centimetri con possibilità di taglio al cm dimensione massima 200x100 cm e antiscivolo integrato.

- Materiale: ceramica
- Altezza: 3 cm
- Larghezza e lunghezza: su misura al centimetro.

L'ambiente bagno è in continua evoluzione, nelle forme, nei colori, nei materiali, ma l'elemento cardine senza il quale non esisterebbe il bagno è da sempre la ceramica.

AZZURRA è da trenta anni presente sul mercato della ceramica sanitaria, e, proprio grazie alla sua esperienza, è riuscita a creare un piatto doccia che per la prima volta riunisce gli elementi fondamentali di un prodotto d'avanguardia con il materiale per eccellenza dell'ambiente bagno.

UNIKO È IL PRIMO PIATTO DOCCIA REALIZZATO UNICAMENTE IN CERAMICA AD ESSERE DISPONIBILE SU MISURA E CON ALTEZZA 3 CM.

AZZURRA è la prima azienda ad aver introdotto nel mercato un piatto doccia Uniko, riuscendo ad unire le caratteristiche divenute ormai un must, l'altezza minima e il prodotto su misura, all'unico materiale immortale dell'ambiente bagno: la ceramica. AZZURRA ha così assicurato ai piatti doccia filo pavimento e su misura il grado di prestazioni ineguagliabile della ceramica in termini di durata, resistenza, facilità di pulizia e igiene. In aggiunta a queste caratteristiche AZZURRA presenta IL PIATTO DOCCIA UNIKO CON UN ANTISCIVOLO NATURALE: LA FINITURA CORTECCIA.

Uniko: the first customizable shower tray in ceramic only 3 cm high with possibility of cutting it to the centimeter maximum dimension 200x100 cm and integrated anti-slip.

- Material: ceramic
- Height: 3 cm
- Width and length: customized to the centimeter.

The bathroom is evolving, in shapes, colors, materials, but the key element without which, the bathroom would not exist, has always been ceramic. Since thirty years Azzurra is on the ceramic market, and, thanks to its experience, has managed to create a shower tray which for the first time brings together the key elements of a cutting-edge product- the minimum height and the tailor made product, with the material of the environment bathroom par excellence: ceramic.

UNIKO IS THE FIRST SHOWER TRAY IN CERAMIC ONLY INTENDED TO BE BESPOKEN AND 3 CM HIGH.

Azzurra has been the first company to introduce into the market Uniko shower tray, able to combine those features which have become a must; the minimum height and a customizable product, with the only immortal material of the bathroom: ceramic. By doing so, Azzurra has assumed a floor level and tailored shower tray, creating a high level product, combining performance of ceramic in terms of durability, resistance, ease of cleaning and hygiene. In addition to these features Azzurra presents the Uniko shower tray with a natural anti-slip: the Corteccia finishing.

2 mt

1 mt

0



PIATTI DOCCIA shower tray

PURO
design: OFFICINA AZZURRA

photographer: Paolo Veciani
photographer: Studio 21



70X90XH3,5



PU 70X90 CO

70X100XH3,5

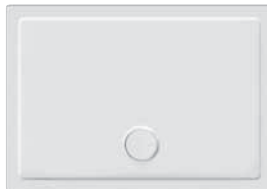

PU 70X100 CO

70X120XH3,5

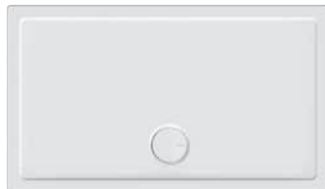

PU 70X120 CO

80X80XH3,5



PU 80X80 CO

80X100XH3,5

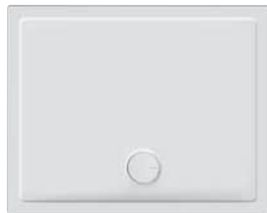

PU 80X100 CO

80X120XH3,5

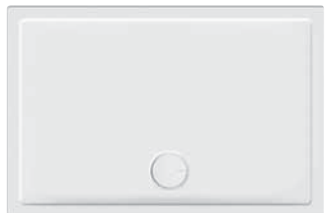

PU 80X120 CO

70X140XH3,5



PU 70X140 CO

80X140XH3,5



PU 80X140 CO

90X90XH3,5



PU 90X90 CO

Piatti doccia **puro** h. 3,5 cm
h. 3,5 cm **puro** shower tray



Trattamento **antibatterico** - **antifungo** applicabile su tutti i prodotti in ceramica e coprivasi.
*The treatment **antibacterial** - **antifungal** can be applied to all ceramic products and seat-cover.*



01.



02.

01. piatto doccia **puro** 120x80 cotone / 120x80 **puro** cotton shower tray
02. piatto doccia **puro** 120x80 filo pavimento / 120x80 **puro** floor level shower tray

PIATTI DOCCIA shower tray

RELAX

design: OFFICINA AZZURRA

photographer: Paolo Veciani
photographer: Studio 21



70X90XH3,5



70X100XH3,5



70X120XH3,5



RE 70X90

RE 70X100

RE 70X120

80X80XH3,5



80X100XH3,5



80X120XH3,5



RE 80X80

RE 80X100

RE 80X120

70X140XH3,5



RE 70X140

80X140XH3,5



RE 80X140

90X90XH3,5



RE 90X90

Piatti doccia **relax** h. 3,5 cm
h. 3,5 cm **relax** shower tray



Trattamento **antibatterico** - **antifungo** applicabile su tutti i prodotti in ceramica e coprivasi.
*The treatment **antibacterial** - **antifungal** can be applied to all ceramic products and seat-cover.*



01.



02.

02. piatto doccia **relax** bianco lucido 120x80 / 120x80 **relax** shiny white shower tray
03. piatto doccia **relax** grigio lucido 120x80 / 120x80 **relax** shiny grey shower tray

Colori disponibili bianco, nero e grigio lucido / Available colors shiny white, shiny black and grey



PRUA

marco zito

render: Studio21

3 Lt
scarico d'acqua
brevettato
WATER SAVING

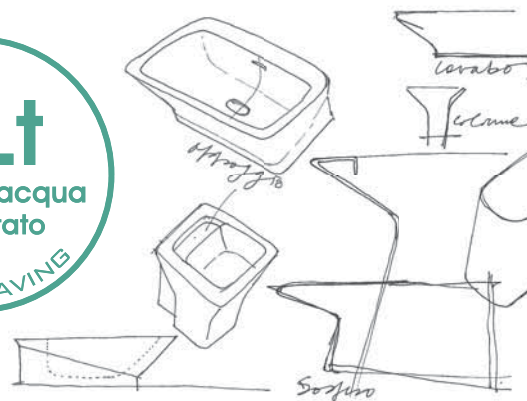

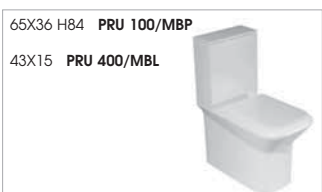

I wc terra e sospesi scaricano con soli 3 lt invece dei tradizionali 9 lt.
Floor and wall hung WCS flush with just 3 litres instead of the traditional 9 lt.



Trattamento **antibatterico** - **antifungo** applicabile su tutti i prodotti in ceramica e copriviassi.
The **antibacterial** - **antifungal** treatment can be applied to all ceramic products and cover-seats.

COLORS 1250°



Piletta con tappo in ceramica disponibile in tutti i COLORS 1250°
Free flow ceramic drain available in all COLORS 1250°
cod. **PILCE**
kg 0,5





vaso e bidet PRUA sospesi PRU 100/SOSK - PRU 500/SOSK. Lavabo appoggio cm 60 PRU 60/IN. Mobile STIVA con 2 cassetti bianchi, specchio PRUA.



PRU 100/SOSK - PRU 500/SOSK PRUA wall hung wc and bidet. PRU 60/IN cm 60 over-counter washbasin. STIVA furniture with 2 white drawers, PRUA mirror.



01.lavabo appoggio/incasso cm 50x40 PRU 50/IN. PRU 50/IN cm 50x40 over counter/inset washbasin.
 02.lavabo appoggio/incasso cm 60x40 PRU 60/IN. PRU 60/IN cm 60x40 over counter/inset washbasin.
 03.lavabo appoggio/incasso cm 70x40 PRU 50/IN. PRU 70/IN cm 70x40 over counter/inset washbasin.



lavabo appoggio/incasso cm 50x40 **COLORS1250°** Cenere PRU 50 CE/IN. Mobile STIVA con 2 cassetti bianchi, specchio orizzontale PRUA.
 PRU 50 CE/IN cm 50x40 over counter/inset washbasin **COLORS1250°** Ash. STIVA furniture with 2 white drawers, PRUA horizontal mirror.



vaso e bidet PRUA sospesi cm 52x35 PRU 100/SOSK - PRU 500/SOSK. Rubinetteria LINEA.
PRU 100/SOSK - PRU 500/SOSK PRUA cm 52x35 wall hung wc and bidet. LINEA taps.



02.



01. bidet sospeso PRUA PRU 500 PE/SOSK. Rubinetteria LINEA
PRU 500 PE/SOSK wall hung bidet. LINEA taps.

02. vaso **COLORS1250°** Tortora sospeso PRUA cm 52x35 PRU 100 TO/SOSK
PRU 100 TO/SOSK wall hung wc **COLORS1250°** Taupe cm 52x35



lavabo sospeso cm 75x45 PRU 275. Mobile sospeso STIVA con 2 cassetti bianchi, specchio orizzontale PRUA. Rubinetteria LINEA PRU 275 cm 75x45 wall hung washbasin. STIVA wall hung furniture with 2 white drawers. PRUA horizontal mirror. LINEA taps.



vaso e bidet a terra cm 52x35 PRU 100 - PRU 500. Rubinetteria LINEA. PRU 100 - PRU 500 cm 52x35 floor mounted wc and bidet. LINEA taps.



lavabo sospeso cm 75x45 PRU 275. Mobile sospeso STIVA con 2 cassetti bianchi.
PRU 275 cm 75x45 wall hung washbasin. STIVA wall hung furniture with 2 white drawers.



01.



02.

01. lavabi sospesi cm 65x45 PRU 265 - cm 75x45 PRU 275 - cm 90x45 PRU 290
PRU 265 cm 65x45 - PRU 275 cm 75x45 - PRU 290 cm 90x45 wall hung washbasins.
02. lavabo sospeso cm 75 PRU 275. Portasciugamani PRUA; specchio verticale PRUA; mobile STIVA a terra con cassettoni.
PRU 275 cm 75 wall hung washbasin. PRUA towel holder; PRUA vertical mirror; STIVA floor furniture with one drawer.



portarotolo PRUA.
toilet roll-holder.



01.



02.



03.



04.

01. portasciugamani PRUA. PRUA towel-holder.
02. portasciugamani PRUA per bidet. PRUA towel-holder for bidet.
03. portascopino e portarotolo PRUA. PRUA toilet brush and toilet roll-holder.
04. portasciugamani PRUA. PRUA towel-holder.



bidet a terra senza foro rubinetteria cm 52x35 PRU 500/0, copribidet PRU 1800. Portasciugamani PRUA.
 PRU 500/0 cm 52x35 floor mounted bidet without tap hole, PRU 1800 cover-seat for bidet, PRUA towel-holder.

Disponibile anche il bidet sospeso senza foro rubinetteria cm 52x35 PRU 500/0 SOSK, copribidet PRU 1800.
 Available also PRU 500/0 SOSK cm 52x35 wall-hung bidet without tap hole, PRU 1800 cover-seat for bidet.



bidet a terra cenere cm 52x35 PRU 500/0 CE con copribidet PRU 1800 CE. Vaso monoblocco cenere PRU 100CE/MBP
 PRU 500/0 cm 52x35 ash floor mounted bidet with PRU 1800 cover-seat for bidet, PRU 100/MBP ash close-coupled wc.

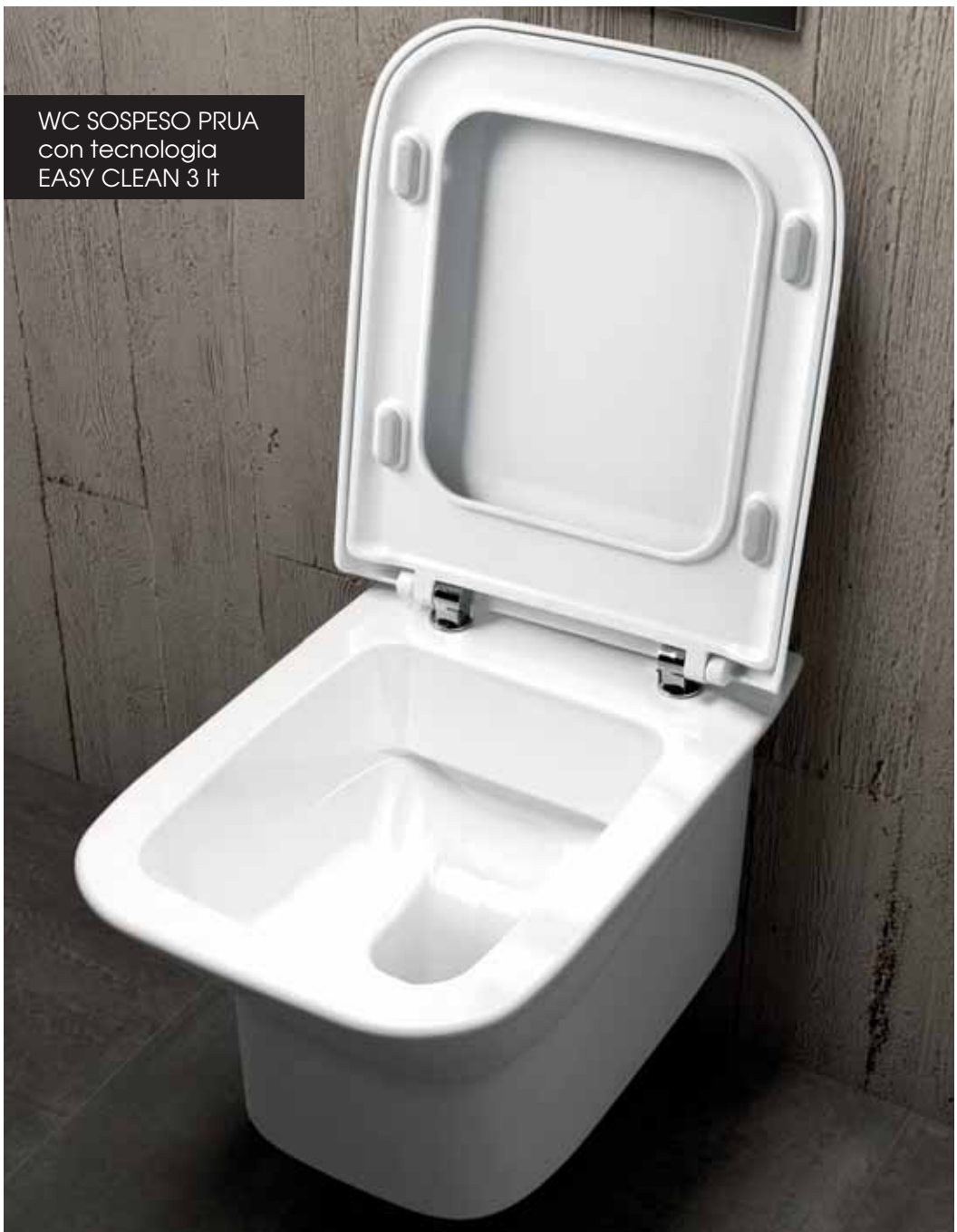

Massimo comfort ed estrema praticità: sono queste le caratteristiche del nuovo copriwater AZZURRA che si stacca con un click per permettere di avere grande facilità di pulizia e massima igiene.

Maximum comfort and extreme practicality: these are the characteristics of the new AZZURRA toilet seats. It can come off with a simple click in order to achieve great ease of cleaning and maximum hygiene.

La vera novità è rappresentata dallo scarico abbinato a questo tipo di forma rientrando così nel progetto Water Saving che riduce al minimo i consumi di acqua destinata allo scarico del wc consumandone non più di 3 litri per un ciclo completo.

The real novelty is in the water release combined with this kind of shape that aims to save water while minimizing the consumption of flushing water thus consuming no more than 3 litres in a complete cycle.



risparmio
idrico 70%
water saving 70%

pulizia facile
e veloce
easy and fast
cleaning

alto livello
visivo di igiene
high visual
hygienic level

In linea con le nuove esigenze di una sempre maggior igiene e di linee basiche, AZZURRA propone un wc senza brida con tecnologia Water Saving, che si inserisce in una nuova tendenza del mercato.

In line with the new demands of increasing hygiene and basic lines, AZZURRA has developed a toilet without flushing rim and Water Saving technology.

PRUA

WC EASY CLEAN 3 Lt scarico traslato

wc easy clean 3 lt adjustable flush system



Esempio / Example

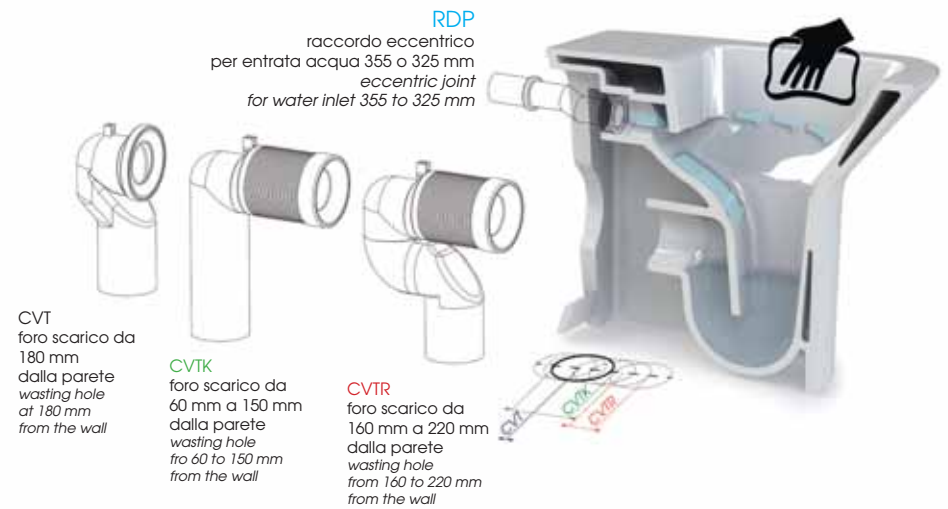

* CVT	CVTK	CVTR	* RDP
da 180 mm from 180 mm	da 60 mm a 150 mm from 60 mm to 150 mm	da 160 mm a 220 mm from 160 mm to 220 mm	355 mm o 325 mm 355 mm or 325 mm

Per ridurre i tempi e i costi di ristrutturazione il centro ricerca Azzurra ha messo a punto, oltre il wc Nuvola, Charme, il wc e bidet Tulip, il wc Prua con scarico traslato, anche il wc Pratica con scarico traslato che può essere installato senza dover modificare l'impianto di scarico esistente.

To reduce the time and costs of renovating a bathroom Azzurra's research centre has developed, besides Nuvola, Charme toilet, Tulip toilet and bidet, Prua toilet with an adaptable outlet, and Pratica toilet with an adaptable outlet which can be installed without modifying the existing outlet system.

TULIP
angeletti ruzza design

photographer: Paolo Veclani
interiors e styling: Michele Pasini, Storage





60X45XH15

TUL 260



45X40XH14

ESO 45



55X36XH42

TUL 500



55X36XH42

TUO 500 TRP scarico traslato



180X80XH60

TUL 113



75X45XH15

TUL 275



60X40XH14

ESO 60

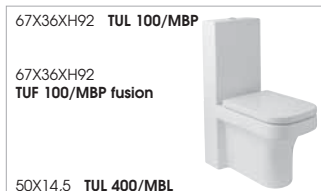

67X36XH92 **TUL 100/MBP**

67X36XH92
TUF 100/MBP fusion

50X14,5 **TUL 400/MBL**



55X36XH42

TUO 100 TRP scarico traslato



190X85XH59

TUL 112



90X48XH15

TUL 290



75X40XH14

ESO 75



55X36XH30

TUO 100/SOSP



70X48 H35

TUL 200/70



90X40XH14

ESO 90



55X36XH21,5

TUO 500/SOSP



H50

TUL 300



55X36XH30

**TUL 100/SOSK
TUF 100/SOSK fusion**



55X36XH42

TUO 100/P



60X35XH41

TUL 200/FR FREESTANDING



55X36XH30

TUL 500/SOSK



55X36XH42

TUO 500



H50

TUL 300FR



55X36XH42

**TUL 100/P
TUF 100/P fusion**



67X36 H92 **TUO 100/MBP**

50X14,5 **TUO 400/MBL**



I wc terra e sospesi scaricano con soli 3 lt invece dei tradizionali 9 lt.
Floor and wall hung WCS flush with just 3 litres instead of the traditional 9 lt.



Trattamento **antibatterico - antifungo** applicabile su tutti i prodotti in ceramica e coprivasi.
The **antibacterial - antifungal** treatment can be applied to all ceramic products and cover-seats.



vaso e bidet Tulip ONE sosp. TUO 100/SOSP - TUO 500/SOSP, lavabo sospeso tulip cm 60 TUL 260 su mobile walnut, specchio Mirror Book, rubinetteria LINEA

TUO 100/SOSP – TUO 500/SOSP Tulip ONE wall-hung WC and bidet, TUL 260 cm. 60 wall-hung washbasin sit on walnut furniture, Mirror Book mirror, LINEA taps



Lavabo sospeso cm 90x48 con portasciugamani cromato. Vaso e bidet sospeso monoforo. Rubinetteria LINEA

cm 90x48 wall-hung washbasin with chromed towel-holder. Wall-hung wc and one-hole bidet. LINEA taps



01.

01.lavabo 75x45 sospeso TUL 275.
Disponibile nelle dimensioni 60x45 TUL 260; 75x45 TUL 275 e 90x48 TUL 290
TUL 275 75x45 wall-hung washbasin.
Available on dimensions 60x45 TUL 260; 75x45 TUL 275 e 90x48 TUL 290



02.



03.



04.

02.lavabo 75 sospeso TUL 275 e lavabo 60 sospeso TUL 260 / TUL 275 75 wall-hung washbasin and TUL 260 60 wall-hung washbasin
03.lavabo 60 sospeso TUL 260 con portasciugamani cromo TUL PU 60 / TUL 260 60 wall-hung washbasin with TUL PU 60 chromed towel-holder
04.lavabo 90 su struttura in ottone cromato TUST 90V / 90 washbasin on TUST 90V chromed metal structure





lavabo 90 TUL 290 su struttura in ottone cromato TUST 90. rubinetteria 3 fori LINEA. specchio MIRROR BOOK.

TUL 290 90 washbasin on TUST 90 chromed metal structure. LINEA 3 holes taps and fittings. MIRROR BOOK Mirror



Lavabo cm 70x48 su colonna in rovere.
Cm. 70x48 washbasin on oak pedestal.



01.



02.



03.

01. Lavabo cm 70x48 su colonna in ceramica / cm. 70x48 washbasin on ceramic pedestal.
02. Lavabo sospeso cm 70x48, / 70x48 wall-hung washbasin
03. Lavabo cm 70x48 in appoggio su mensola 170 laccata bianco lucido / cm. 70x48 cm washbasin on 170 lacquered shiny white counter top.



01. lavabo incasso/appoggio SOFT cm 45x40 ESO 45. ESO 45 cm 45x40 inset/over-counter washbasin.
 02. lavabo incasso/appoggio SOFT cm 60x40 ESO 60. ESO 60 cm 60x40 inset/over-counter washbasin.
 03. lavabo incasso / appoggio SOFT cm 75x40 ESO 75. ESO 75 cm 75x40 inset/over-counter washbasin.
 04. lavabo incasso/ appoggio SOFT cm 90x40 ESO 90. ESO 90 cm 90x40 inset/over-counter washbasin.



lavabo incasso/appoggio SOFT cm 60x40 ESO 60, mensola MISURA.
 ESO 60 cm 60x40 inset/over-counter washbasin, MISURA shelf.



lavabo freestanding con colonna in ceramica TUL200FR - TUL 300FR
TUL 200FR/ST - TUL 300FR Freestanding washbasin with ceramic pedestal



01.



02.



03.

01.lavabo freestanding TUL 200FR su colonna finitura in rovere TUL 300 FR
TUL 200FR 60 freestanding washbasin on TUL 300 FR oak-wood finishing pedestal
02.lavabo freestanding TUL 200FR su colonna in ceramica TUL 300FR
TUL 200FR 60 freestanding washbasin on TUL 300FR ceramic pedestal
03.lavabo 60 TUL 200FR in appoggio su mensola
TUL 200FR 60 washbasin sit on counter top



Vasca freestanding cm 190x85 TUL113 in CRYSTALTECH con portasciugamani cromato.
TUL113 cm 190x85 CRYSTALTECH freestanding bathtub with chromed towel-holder.



Vasca in acrilico cm 180x80 TUL112 con rinforzo in vetroresina.
TUL112 cm 180x80 acrylic bath-tub with fibreglass reinforcement.



01. vaso sospeso TUL 100/SOSK con sedile avvolgente a chiusura frizionata TUL 1800/F; bidet sospeso monoforo TUL 500/SOSK.
 Piatto doccia PURO cm 70x100 PU 70x100 CO finitura cotone.
 TUL 100/SOSK wall hung wc with TUL 1800/F wrapping cover-seat with soft-closing; TUL 500/SOSK one-hole wall hung bidet.
 PU 70x100 cm 70x100 Puro shower tray cotton finishing.



02.



02. bidet a terra monoforo TUL 500 / TUL 500 one-hole bidet

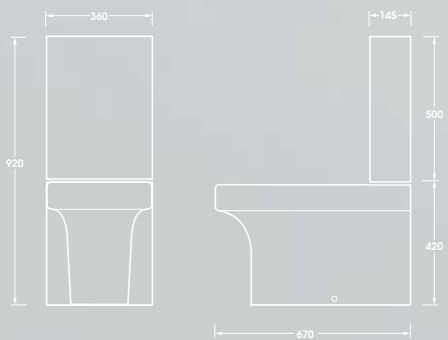

01.

01. vaso monoblocco con scarico a parete trasformabile a pavimento tramite curva tecnica in plastica TUL 100/MBS - TUL 100/MBP e cassetta monoblocco TUL 400/MBL; sedile avvolgente a chiusura frizionata TUL 1800/F



01. TUL 100/MBS - TUL 100/MBP wall trap close coupled wc convertible into floor trap with a plastic technical bend and TUL 400/MBL close coupled cistern; TUL 1800/F wrapping cover-seat with soft-closing.

WC

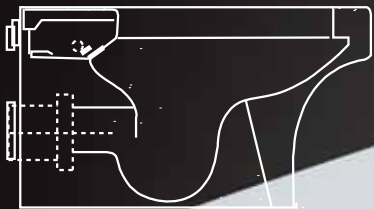

fusion

Il bidet è comunemente presente solamente in alcuni paesi europei: Grecia, Italia, Spagna e Portogallo. Nel Nord Europa, in Francia, in Inghilterra e in America non si utilizza per scelta culturale e, in alcuni casi, per le piccole dimensioni che vengono riservate ai bagni, specialmente in città.

AZZURRA propone, a partire dalla collezione Tulip, uno speciale vaso multifunzione, nella versione sospesa, terra e monoblocco, che unisce al wc la funzione dell'igiene intima, ottimizzando gli spazi.

Il design del pezzo ceramico non viene minimamente alterato e il copriwater resta lo stesso. Un miscelatore monocomando posizionato sulla parete accanto al wc regola il volume e la temperatura dell'acqua che fuoriesce da un areatore posizionato dentro il vaso e garantisce un flusso di acqua limpida. Le funzioni del WC e del BIDET si fondono in un'unica soluzione che garantisce igiene e praticità d'uso, aumentano gli spazi in bagno e si riduce drasticamente l'uso della carta igienica - ogni giorno 270.000 alberi finiscono nel gabinetto come carta igienica o vengono buttati come spazzatura. Solo nell'intera Europa si arriva al consumo di 22 miliardi di rotoli complessivi all'anno.



bidet

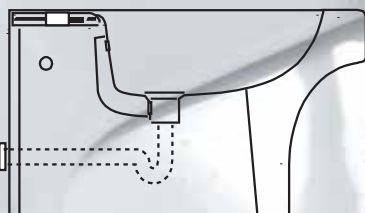

fusion

The bidet is commonly found only in some European countries such as Greece, Italy, Spain and Portugal. In Northern Europe, France, England and America it is not used for cultural choice, and in some cases, due to the small size of the bathroom, especially in cities. AZZURRA presents, from the Tulip collection, a special multi-function WC, available as wall hung, floor and monoblock version. It allows to combine the WC with the intimate hygiene function so that is possible to optimize space.

The ceramic piece design is not altered at all, as well as the toilet seats remains the same. A single-control mixer positioned on the wall next to the toilet allows to adjust the temperature and pressure of the water coming out from a water supply located inside the WC and ensures a flow of clear water.

The toilet and bidet function merge into a single solution that ensures hygiene and ease of use, increase the space in the bathroom and drastically reduces the use of toilet paper - 270,000 trees every day end up as toilet paper down the toilet or are discarded like trash. Only in Europe the total consumption amounts at 22 billion of rolls every year.

fusion

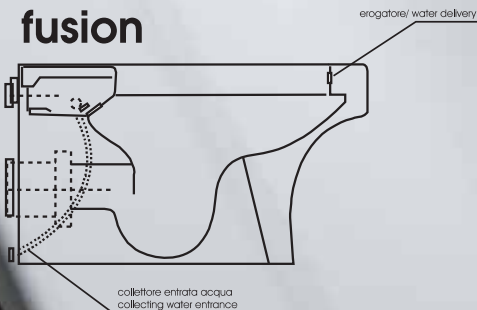

01.



02.



03.



04.



02.vaso/bidet monoblocco Tulip FUSION con scarico a parete trasformabile a pavimento TUF 100/MBS - TUF 100/MBP e cassetta monoblocco TUL 400/MBL; sedile avvolgente a chiusura frizionata TUL 1800/F. monocomando LINEA / TUF 100/MBS - TUF 100/MBP Tulip FUSION wall trap close coupled wc/bidet convertible into floor trap and TUL 400/MBL close coupled cistern; TUL 1800/F wrapping cover-seat with soft-closing LINEA single control mixer.

03.vaso/bidet sospeso Tulip FUSION TUF 100/SOSK. monocomando LINEA TUF 100/SOSK Tulip FUSION wall-hung wc/bidet. LINEA single control mixer

04.particolare uscita acqua / detail of water flow





01.

01. vaso sospeso TUO 100/SOSP e bidet sospeso TUO 500/SOSP 55 cm
TUO 100/SOSP cm55 wall-hung wc and TUO 500/SOSP cm55 wall-hung bidet



02.



03.

02. vaso monoblocco con scarico a parete trasformabile a pavimento tramite curva tecnica in plastica TUO 100/MBS - TUO 100/MBP e cassetta monoblocco TUL 400/MBL; sedile avvolgente a chiusura frizionata TUL 1800/F / TUO 100/MBS - TUO 100/MBP wall trap close coupled wc convertible into floor trap with a plastic technical bend and TUL 400/MBL close coupled cistern; TUL 1800/F wrapping cover-seat with soft-closing.
03. vaso a terra TUO 100 e bidet a terra TUO 500 / TUO 100 floor wc and TUO 500 floor bidet





TULIP ONE

wc e bidet scarico traslato/wc and bidet with adjustable trap

vecchio impianto vaso
old wc installation

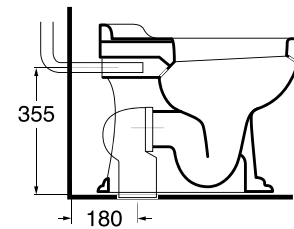

vaso tulip one installato
su vecchio impianto
tulip one wc old installation

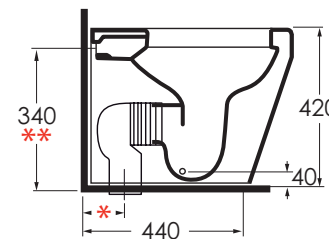

* CVT	CVTK	CVTR	** RDP
180mm	da 60mm a 150 mm	da 160mm a 220 mm	mm 355 o mm 325

vecchio impianto bidet
old bidet installation

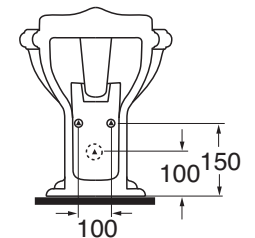

bidet tulip one installato
su vecchio impianto
tulip one bidet old installation

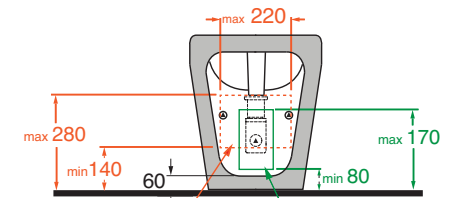

range di movimento
utenze acqua calda e fredda
hot and cold water supply motion
range

range di movimento
altezza centro scarico del sifone
height motion range of the centre
siphon discharge

scarico traslato vaso

Per agevolare le ristrutturazioni il centro ricerche di AZZURRA ha creato il nuovo wc TULIP ONE, che può essere installato senza dover modificare impianti di scarico esistenti. Considerando che i vecchi impianti riportano uno scarico tra i 60 mm e i 220 mm di distanza dal muro (misure dell'interasse), il nuovo wc TULIP ONE può essere installato in quasi tutte le situazioni esistenti, avendo un range di interasse di 160 mm. Attraverso un'attenta e meticolosa ricerca, senza modificare l'estetica del pezzo, TULIP ONE traslato risolve pienamente una problematica progettuale, che soddisfa l'utente con un ampio risparmio economico.

WC with adjustable trap

In order to facilitate the restructuring process, Azzurra technical department has developed the new TULIP ONE WC, which can be installed without modifying the existing discharge installations.

Most of the existing bathrooms have a center to center flush distance between 60 and 220 mm away from the wall; having a center to center range of mm. 160, the new TULIP ONE WC, can be installed in almost all existing situations. Through a painstaking and meticulous research, the TULIP ONE WC with adjustable discharge fully solve a design problem, without changing the aesthetics of the piece. Therefore is able to satisfy the users with a large cost savings.

scarico traslato bidet

Per completare il bagno senza dover modificare gli impianti esistenti, AZZURRA ha creato anche il nuovo bidet TULIP ONE "traslato". Con un range di movimento che va da un minimo di 140 mm ad un massimo di 280 mm per l'altezza delle utenze di acqua calda e fredda, un interasse di massimo 220 mm ed un range di movimento del centro scarico del sifone che va da un minimo di 80 mm ad un massimo di 170 mm di altezza, il bidet TULIP ONE può essere adattato ai vecchi impianti già esistenti.

Bidet with adjustable trap

To complete the bathroom without having to modify existing installations, Azzurra has also created a new TULIP ONE bidet with adjustable discharge.

The TULIP ONE bidet can be easily adapted to existing bathroom thanks to the following technical features: hot and cold water supply height motion range from a minimum of mm 140 to a maximum of mm 280. A center to center of maximum mm 220 and an height motion range of the centre siphon discharge from a minimum of mm 80 to a maximum of mm 170. With a range of motion that ranges from a minimum of 140 mm to a maximum of 280 mm for the height of the loads of hot and cold water, a wheelbase of 220 mm and a maximum range of motion of the center of the siphon drain that goes from a minimum of 80 mm to a maximum of 170 mm in height, bidet TULIP ONE can be adapted to existing old installations.



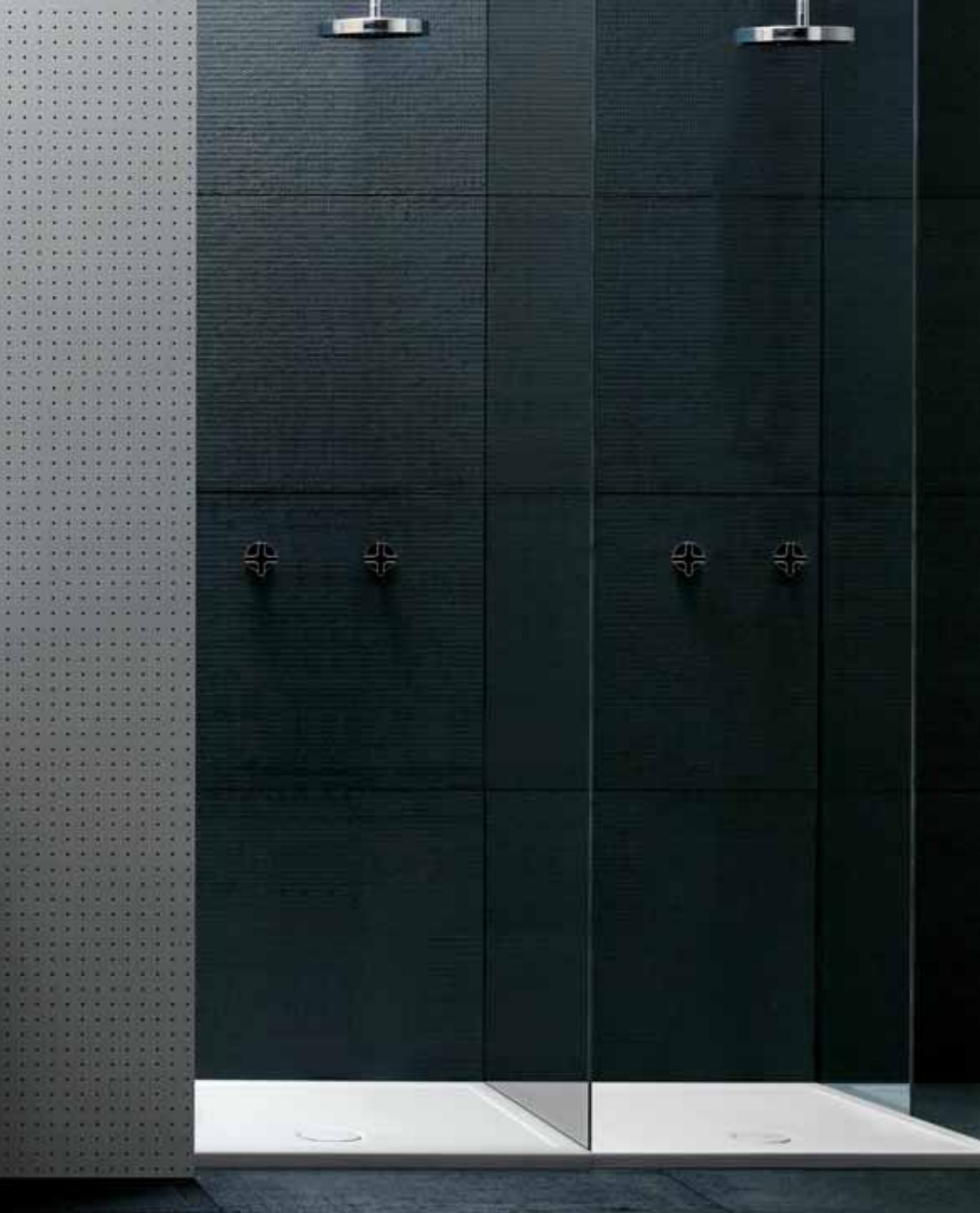

Piatti doccia **PURO** cotone cm 80x80.
Cm 80x80 **PURO** cotton shower tray.



01.



02.

01, piatto doccia **RELAX** 120x80 bianco lucido / 120x80 **RELAX** shiny white shower tray
Disponibile anche nei colori grigio e nero / Available also grey and black colors

02, piatto doccia **PURO** 120x80 cotone / 120x80 **PURO** cotton shower tray



Lavabo incasso 75 su mobile 170 sospeso laccato bianco opaco con cassettoni
Inset washbasin 75 on wall-hung lacquered mat white furniture 170 with two big drawers



01.



02.

01.lavabi 60 ad incasso su mensola 115 in rovere ME 115 R con portasciugamani cromato cm 100, PUM 115
Inset washbasin 60 on oak shelf 115 ME 115 with chromed towel-holder 100 cm PUM 115
02.lavabo 75 in appoggio su mensola 170 laccata bianco lucido ME 170 B con portasciugamani cromato cm 155, PUM 170
over-counter washbasin 75 on lacquered polished white shelf 170 ME 170 B with chromed towel-holder 155 cm PUM 170



lavabo TULIP su colonna bianco COTONE.
TULIP washbasin on pedestal COTTON white.

CLAS +
design: Claudio Papa

photographer: Paolo Veclani
interiors e styling: Michele Pasini, Storage





55X45XH19

CLA 200/55



Ø40XH14

ECI 40



50X38.5XH30

CLP 150/SOSK



56X39XH42

CLP 500M



180X95 H62

CLA 113



65X48XH20

CLA 200/65



60X40XH14

ECI 60



50X38.5XH30

CLP 550/SOSK



72X41 H95.5
CLP 100/MBP

50X16
CLP 400/MBL



180X84 H75

CLA 112



75X50XH20

CLA 200/75



60X42XH14

ECI 60M



50X38.5XH42

CLP 150/P



90X50XH20

CLA 200/90



70X42XH14

ECI 70M



50X38.5XH42

CLP 550



45X45XH15

CLI 45



70X42XH14

ECI 70



56X39XH30

CLP 100/SOSK



60X45XH15

CLI 60



90X44XH14

ECI 90M



56X39XH29

CLP 500/SOSK

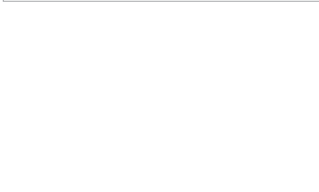

90X44XH14

ECI 90



56X39XH42

CLP 100/P



I wc terra e sospesi scaricano con soli 3 lt invece dei tradizionali 9 lt.
Floor and wall hung WCS flush with just 3 litres instead of the traditional 9 lt.



Trattamento **antibatterico - antifungo** applicabile su tutti i prodotti in ceramica e coprivasi.
The **antibacterial - antifungal** treatment can be applied to all ceramic products and cover-seats.



lavabo appoggio CIRCLE cm 90 ECI 90 su mobile bianco opaco con due cassettoni,
vaso e bidet sospeso Mini Clas CLA 150 sosk - CLA 550 sosk.
ECI 90 cm 90 CIRCLE over-counter washbasin on matt white furniture with drawers,
CLA 150 sosk- CLA 550 sosk Mini Clas wall-hung WC and bidet



vasca Clas CLA 113, lavabo sospeso cm 75 CLA 200/75, specchio Mirror Book.
CLA 113 Clas bath-tube, CLA 200/75 cm 75 wall-hung washbasin, Mirror Book.

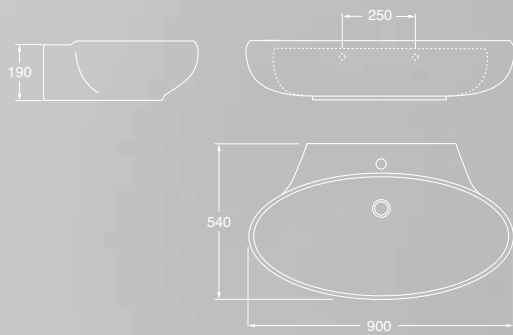

01.



02.



03.



04.



05.



06.

lavabo 90x50 sospeso senza foro CLA 200/90M.
 Disponibile nelle dimensioni 55x45 CLA 200/55; 65x48 CLA 200/65; 75x50 CLA 200/75 e 90x54 CLA 200/90
 CLA 200/90M 90x50 wall hung washbasin without hole.
 Available on dimensions 55x45 CLA 200/55; 65x48 CLA 200/65; 75x50 CLA 200/75 and 90x54 CLA 200/90

01.lavabo 75 monoforo CLA 200/75 su semicolonna CLA 300/SOSP / CLA 200/75 75 one-hole washbasin on CLA 300/SOSP semi-pedestal
 02.lavabo 75 sospeso monoforo CLA 200/75 con portasciugamani CL PU/6575 / CLA 200/75 75 wall-hung one-hole washbasin with CL PU/6575 towel-holder
 03.lavabo 55 da appoggio senza foro rubinetteria CLA 200/55M / CLA 200/55M 55 over-counter washbasin
 04.lavabo 75 monoforo CLA 200/75 su colonna CLA 300 / CLA 200/75 75 one-hole washbasin on CLA 300 pedestal
 05.lavabo 55 sospeso monoforo CLA 200/55 con portasciugamani CL PU/55 / CLA 200/55 55 wall-hung one-hole washbasin with CL PU/55 towel-holder
 06.lavabo 55 monoforo CLA 200/55 su semicolonna CLA 300/SOSP / CLA 200/55 55 one-hole washbasin on CLA 300/SOSP semipedestal



lavabo appoggio cm 70 CLR 70, mobile walnut cm 90 MBA 90 W, rubinetteria Linea, specchio Mirror Book.
CLR 70 cm 70 over-counter washbasin, MBA 90 W cm 90 walnut furniture, Linea taps and fittings, Mirror Book.



piatto doccia UNIKO 90x90 cm finitura cotone, colonna doccia rubinetteria LINEA.
UNIKO cm 90x90 cotton finishing shower tray, LINEA taps shower.



- 01. lavabo appoggio CIRCLE cm 40x40 ECI 40. ECI 40 cm 40x40 over counter washbasin.
- 02. lavabo appoggio CIRCLE cm 60x40 ECI 60. ECI 60 cm 60x40 over counter washbasin.
- 03. lavabo appoggio CIRCLE cm 70x42 ECI 70. ECI 70 cm 70x42 over counter washbasin.
- 04. lavabo appoggio CIRCLE cm 90x44 ECI 90. ECI 90 cm 90x44 over counter washbasin.



lavabo appoggio monoforo CIRCLE cm 70x42 ECI 70M. Rubinetteria LINEA, mensola MISURA cotone.
ECI 70M cm 70x42 one hole over counter washbasin. LINEA taps, MISURA cotton shelf.



lavabo appoggio CIRCLE cm 40x40 ECI 40.
ECI 40 cm 40x40 over counter washbasin.





lavabo appoggio CIRCLE cm 60x40 ECI 60. Rubinetteria LINEA, mensola MISURA cotone.
ECI 60 cm 60x40 over counter washbasin. LINEA taps, MISURA cotton shelf.



01.



02.

01. lavabo appoggio CIRCLE cm 60x40 ECI 60. ECI 60 cm 60x40 over counter washbasin.
02. lavabo appoggio monoforo CIRCLE cm 60x42 ECI 60M. ECI 60M cm 60x42 one hole over counter washbasin.



vaso e bidet mini Clas terra CLA 150 - CLA 550
CLA 150 – CLA 550 Mini Clas floor WC and bidet



01.



02.



03.



04.



05.



- 01.vaso sospeso mini clas CLA 150/SOSK / CLA 150/SOSK MINI CLAS wall-hung wc
- 02.bidet monoforo CLA 500/M / CLA 500/M one-hole bidet
- 03.bidet sospeso monoforo mini clas CLA 550/SOSK / CLA 550/SOSK wall-hung one-hole bidet
- 04.bidet mini clas sospeso 50 CLA 550/SOSK e bidet sospeso 55 CLA 500/SOSK
CLA 550/SOSK 50 MINI CLAS wall-hung bidet and CLA 500/SOSK 55 wall-hung bidet
- 05.bidet 50 sospeso CLA 550/SOSK e bidet 56 sospeso CLA 500/SOSK
CLA 550/SOSK 50 wall-hung bidet and CLA 500/SOSK 56 wall-hung bidet





vaso monoblocco CLA 100 MB
CLA 100 MB close coupled WC



vasca clas cm 180 CLA 113, rubinetteria LINEA
CLA 113 Clas bath-tub, LINEA taps and fittings



01.

01.vasca in acrilico con rinforzo in vetroresina cm 180x95 CLA 113 / CLA 113 cm 180x95 acrylic bath-tub with fibreglass reinforcement

02.

02.vasca in acrilico con rinforzo in vetroresina cm 180x71 CLA 112 / CLA 112 cm 180x71 acrylic bath-tub with fibreglass reinforcement



01.



02.

01.lavabo CLAS+ 75 COLORS 1250° COTONE / CLAS+ 90 washbasin COLORS 1250° COTTON
 02.vaso e bidet Mini CLAS COLORS 1250° COTONE / Mini CLAS Wc and bidet COLORS 1250° COTTON

NUVOLA

angeletti ruzza design

photographer: Paolo Veclani
interiors e styling: Michele Pasini, Storage

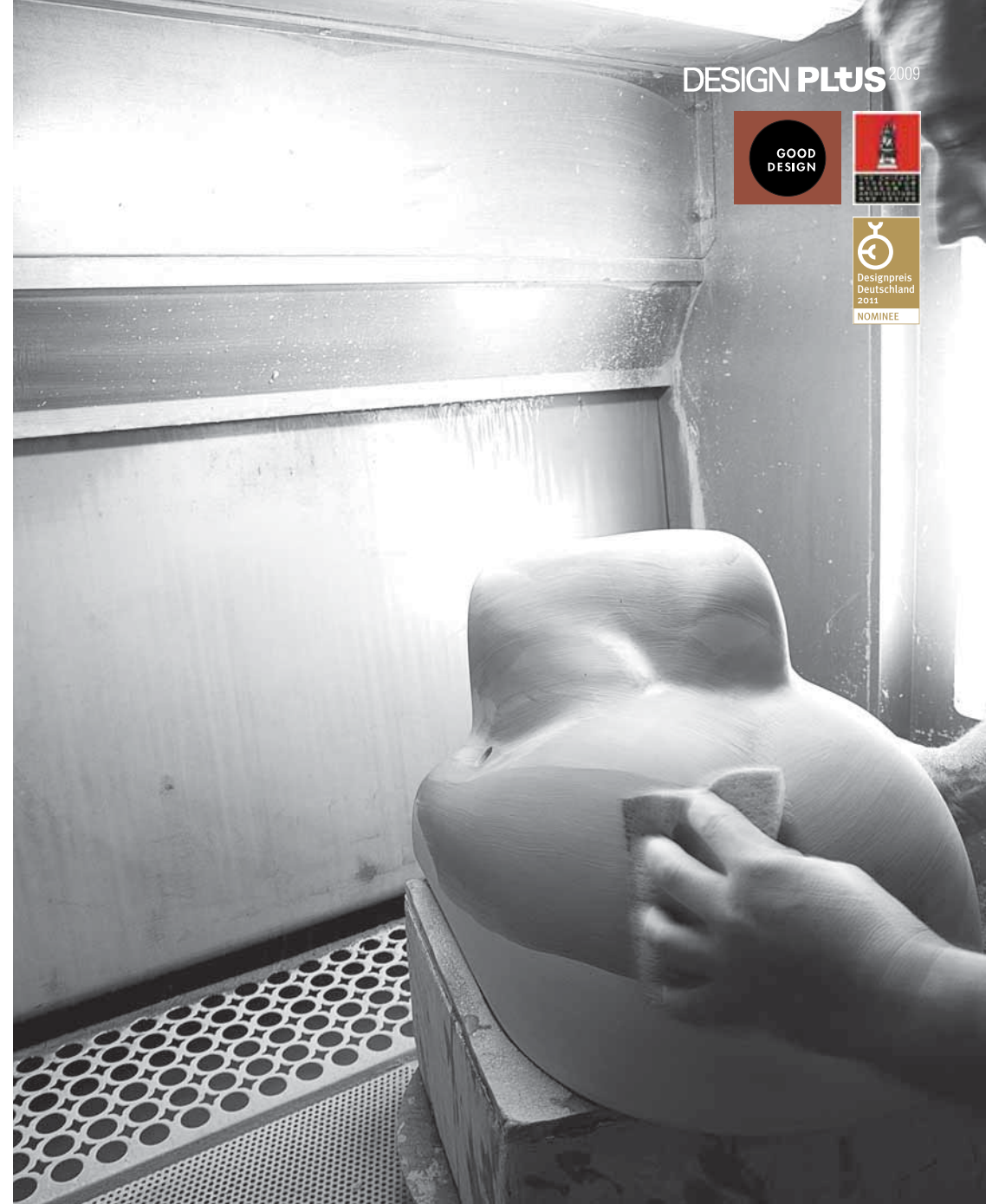

DESIGN PLUS 2009



GOOD DESIGN. NUVOLA entra a far parte della collezione permanente del CHICAGO ATHENAEUM
GOOD DESIGN. NUVOLA has joined the CHICAGO ATHENAEUM permanent collection



47X37XH15
NUV 246



60X45XH17
NUV 200/60



75X45XH17
NUV 200/75



90X45XH17
NUV 200/90



60X40XH16
NUV 200/AP6



75X40XH16
NUV 200/AP8



45X45XH15
CLI 45



60X45XH15
CLI 60



Ø40,5XH17
GRA AP4



Ø40,5 H85
GRA 01



46X35XH24,5
NUV 546/SOSK



46X35XH33
NUV 146/SOSK



46X35XH42
NUV 546



46X35XH42
NUV 146/P



55X35XH24
NUV 500/SOSK



55X35XH33
NUV 100/SOSK



55X35XH42
NUV 500



55X35XH42
NUV 100/P



65X35XH84
NUV 100/MBP



55X35XH42
NUV 100/TR P SCARICO TRASLATO

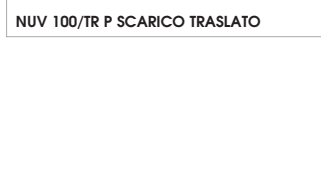

43X15
NUV 400/MBL



55X35XH48
H48 NUV 500/48



55X35XH48
H48 NUV 100/48



55X35XH48
H48 NUV 100/48 TR P SCARICO TRASLATO



35,5X29XH55
NUV 100/OR

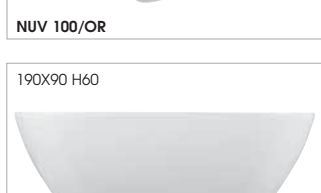

190X90 H60
NUV 112



55X35XH33
NUV 100 E/SOSK EASY CLEAN



55X35XH42
NUV 100 E/TRP EASY CLEAN TRASLATO



I wc terra e sospesi scaricano con soli 3 lt invece dei tradizionali 9 lt.
Floor and wall hung WCS flush with just 3 litres instead of the traditional 9 lt.



Trattamento antibatterico - antifungo applicabile su tutti i prodotti in ceramica e coprivasi.
The antibacterial - antifungal treatment can be applied to all ceramic products and cover-seats.



vaso e bidet sospesi 55. Lavabo 60 da appoggio NUV 200/AP6.



55 cm wall-hung wc and bidet. NUV 200/AP6 60 over-counter washbasin.

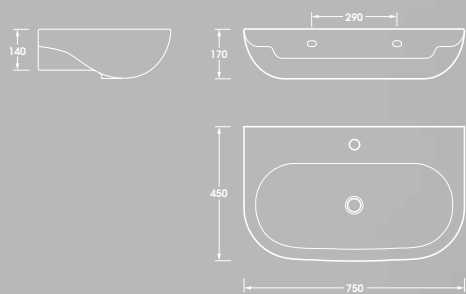

02.



01.

01. lavabo 75 sospeso NUV 200/75, disponibile nelle dimensioni 60x45 NUV 200/60; 70x45 NUV 200/75 e 90x45 NUV 200/90. NUV 200/75 wall-hung washbasin. Available on dimensions 60x45 NUV 200/60; 70x45 NUV 200/75 and 90x45 NUV 200/90.



03.

02. lavabo 90 monoforo sospeso NUV 200/90. NUV 200/90 90 wall-hung one hole washbasin.
03. lavabo 75 monoforo sospeso NUV 200/75. NUV 200/75 75 wall-hung one hole washbasin.



lavabo 75 cm sospeso NUV 200/75. Specchio MIRROR BOOK.
NUV 200/75 cm 75 wall-hung washbasin.MIRROR BOOK mirror.



lavabo 90 cm sospeso NUV 200/90. Specchio MIRROR BOOK e rubinetteria cromo LINEA.
NUV 200/90 cm 90 wall-hung washbasin.MIRROR BOOK mirror and LINEA chromed taps.



la collezione CLIP è disponibile anche nella finitura CORTECCIA.
CLIP collection is also available with CORTECCIA finishing.

CORTECCIA





01

02

03

01.lavabo ø40,5 da appoggio GRA AP4 in terracotta naturale o smaltato in 8 varianti di colore. Riferimento tabella colori, nelle schede tecniche GRA AP4 ø40,5 over-counter washbasin made of natural earthenware or enamelled in 8 different colours. The colour list is available in the technical area.

02.lavabo 60 da appoggio NUV 200/AP6 / NUV 200/AP6 60 over-counter washbasin

03.lavabo 75 da appoggio NUV 200/AP8 / NUV 200/AP8 75 over-counter washbasin



01.

01.lavabo 75 in appoggio NUV 200/AP8 / NUV 200/AP8 75 over-counter washbasin



01.



02.

01.lavabo appoggio CLIP cm 45 CLI 45 / CLI 45 cm. 45 over-counter washbasin
02.lavabo appoggio CLIP cm 60 CLI 60 / CLI 60 cm. 60 over-counter washbasin



CLIP è disponibile anche nella finitura CORTECCIA.
CLIP collection is also available in CORTECCIA finishing.



01.

01. lavabo GRAAL in terracotta naturale o smaltato in 8 varianti di colore. Riferimento tabella colori, nelle schede tecniche
 GRAAL washbasin made of natural earthenware or enamelled in 8 different colours. The colour list is available in the technical area.



lavabo Graal in terracotta smaltato / Graal washbasin made of enamelled earthen



01.



02.

01.vaso sospeso 46 NUV 146/SOSK / NUV 146/SOSK 46 wall-hung wc
 02.vaso sospeso NUV 146/SOSK con sedile avvolgente in termoindurente NUV 1845; bidet sospeso monoforo NUV 546/SOSK
 NUV 146/SOSK wall-hung wc with NUV 1845 wrapping thermosetting cover-seat; NUV 546/SOSK wall-hung one-hole bidet





vaso e bidet 46 sospesi. Lavabo 47 sospeso NUV 246
46 wall-hung wc and bidet. NUV 246 47 wall-hung washbasin



01.



02.



03.



04.



01. bidet sospeso 55 e bidet sospeso 46 / 55 wall-hung bidet and 46 wall-hung bidet
02. bidet sospeso monoforo 46 NUV 546/SOSK / NUV 546/SOSK 46 wall-hung one-hole bidet
03. vaso sospeso 46 NUV 146/SOSK / NUV 146/SOSK 46 wall-hung wc
04. bidet 46 sospeso NUV 546/SOSK e bidet 55 sospeso NUV 500/SOSK
NUV 546/SOSK 46 wall-hung bidet and NUV 500/SOSK 55 wall-hung bidet

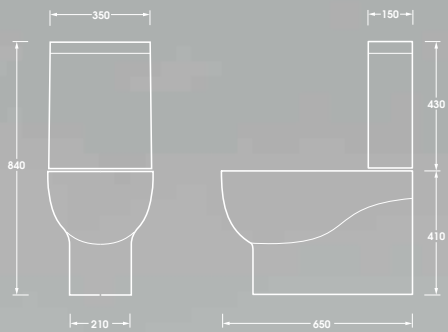

01.

01.vaso monoblocco con scarico a parete trasformabile a pavimento tramite curva tecnica in plastica NUV 100/MBS - NUV 100/MBP e cassetta monoblocco NUV 400/MBL
 NUV 100/MBS - NUV 100/MBP wall trap close coupled wc convertible into floor trap with a plastic technical bend with NUV 400/MBL close coupled cistern



02.

02.vaso monoblocco e bidet monoforo NUVOLA
 NUVOLA close coupled wc and one hole bidet



orinatoio NUV 100/OR con comando a parete LINEA.
NUV 100/OR urinal with LINEA wall control.



nuvola H48



H48

Per andare incontro alle nuove esigenze di mercato AZZURRA propone all'interno della collezione NUVOLA, il wc e bidet terra H48.

Dai dati ISTAT, si evince che la nostra altezza media è in costante aumento. (Italia, 175cm).

Nei paesi europei e extraeuropei, tale soglia in alcuni casi è stata già raggiunta e superata.

Ad esempio:

germania. 180cm

olanda. 182,5cm

sud africa. 177,7cm

australia. 177cm.

H48 nasce per agevolare la seduta, andando incontro alle nuove ergonomie d'uso.

In linea con la collezione, H48 può essere montata con scarico a terra o parete.

H48

To meet new market demands AZZURRA proposes, as part of NUVOLA collection, the H48 floor toilet and bidet.

According to ISTAT analysis, our average height is constantly increasing. (Italy, 175cm).

In European countries and outside Europe, the above threshold, in some cases, has already been reached and exceeded. For example:

Germany. 180cm

Netherlands. 182.5 cm

South Africa. 177.7 cm

Australia. 177cm

H48 was conceived to facilitate the sitting, meeting the new ergonomics needs. As well as the Nuvola collection, H48 is available both floor or wall trap.

h.42

h.48

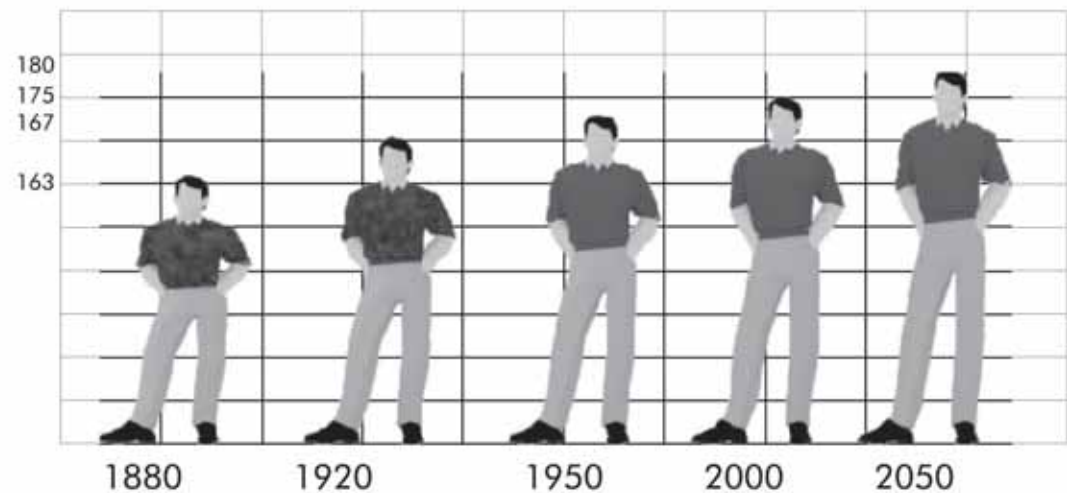

bidet terra cm 55 H48 NUV 500/48 e vaso terra H48 cm 55 NUV 100/48 / NUV 500/48 cm 55 H48 floor standing bidet and NUV 100/48 cm 55 H48 floor standing WC





01.



02.



03.

01. vaso terra cm. 46 cod. NUV 146 / NUV 146 cm. 46 floor standing WC
 02. vaso 55 con scarico a parete trasformabile a pavimento tramite curva tecnica in plastica NUV 100/S - NUV 100/P con sedile avvolgente in termoindurente a chiusura frizionata NUV 1800/F; bidet monoforo NUV 500 NUV 100/S - NUV 100/P 55 wall trap wc convertible into floor trap with a plastic technical bend with NUV 1800/F wrapping thermosetting cover-seat with soft-closing; NUV 500 one-hole bidet
 03. vaso terra cm. 55 cod. NUV 100/S - NUV 100/P; vaso terra H48 cm 55 NUV 100/48 / NUV 100/S - NUV 100/P cm 55 floor standing WC;
 NUV 100/48 cm 55 H48 floor standing WC



NUVOLA

WC H48 SCARICO TRASLATO

wc H48 adjustable flush system



Esempio / Example

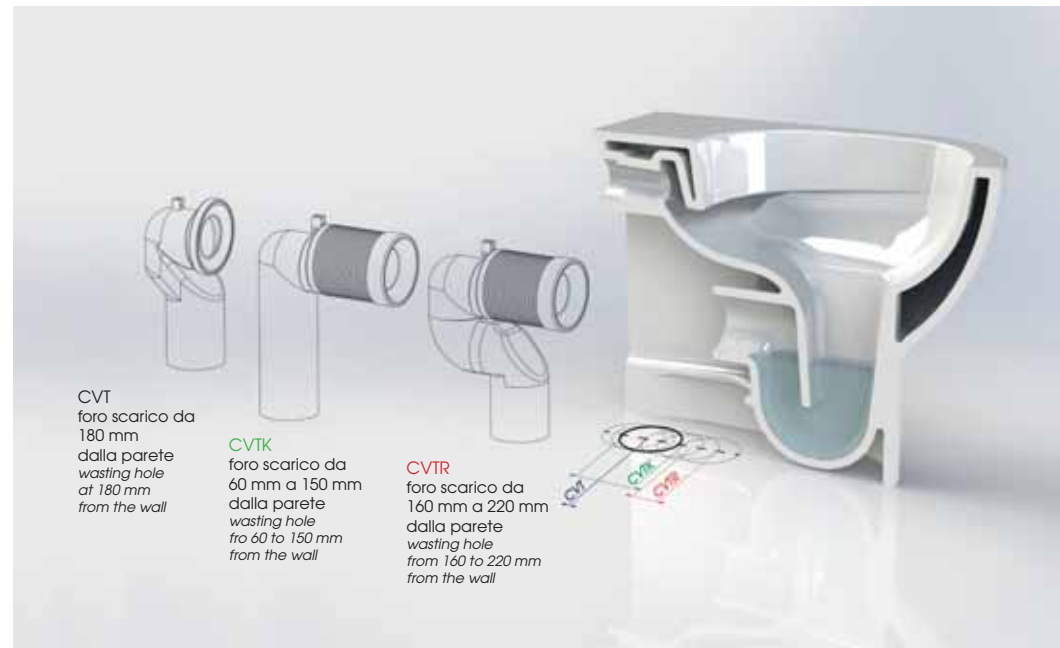

Per ridurre i tempi e i costi di ristrutturazione il centro ricerca Azzurra ha messo a punto, oltre il wc Nuvola, Nuvola H48, Charme, il wc e bidet Tulip, il wc Prua con scarico traslato, anche il wc Pratica con scarico traslato che può essere installato senza dover modificare l'impianto di scarico esistente.

To reduce timing and costs about bathroom renovation Azzurra's research centre has developed, besides Nuvola, Nuvola H48, Charme toilet, Tulip toilet and bidet, Prua toilet with an adaptable outlet, and Pratica toilet with an adjustable outlet which can be installed without modifying the existing outlet system.

NUVOLA

WC SCARICO TRASLATO

adjustable flush system



Esempio / Example



Vaso a terra bainco lucido cm 55 NUV 100/TRP SCARICO TRASLATO a pavimento.
Cm 55 NUV 100/TRP shiny white floor trap with adjustable flush system.

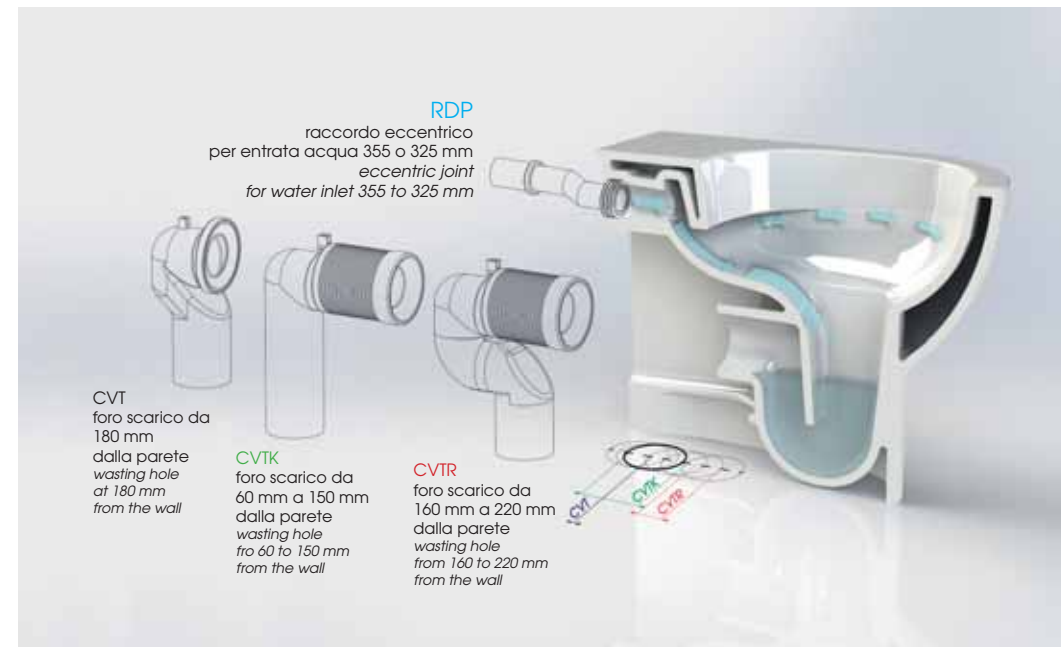

Per ridurre i tempi e i costi di ristrutturazione il centro ricerca Azzurra ha messo a punto, oltre il wc Nuvola, Nuvola H48, Charme, il wc e bidet Tulip, il wc Prua con scarico traslato, anche il wc Pratica con scarico traslato che può essere installato senza dover modificare l'impianto di scarico esistente.

To reduce timing and costs about bathroom renovation Azzurra's research centre has developed, besides Nuvola, Nuvola H48, Charme toilet, Tulip toilet and bidet, Prua toilet with an adaptable outlet, and Pratica toilet with an adjustable outlet which can be installed without modifying the existing outlet system.



3 Lt
 scarico d'acqua
 brevettato
 WATER SAVING



WC NUVOLA SOSPESO
 con tecnologia
EASY CLEAN 3 lt
 WALL HUNG WC NUVOLA
 with 3lt EASY CLEAN
 technology



- 
**risparmio
 idrico 70%**
 water saving 70%
- 
**pulizia facile
 e veloce**
 easy and fast
 cleaning
- 
**alto livello
 visivo di igiene**
 high visual
 hygienic level

In linea con le nuove esigenze di una sempre maggior igiene e di linee basiche, AZZURRA propone un wc senza brida, che si inserisce in una nuova tendenza del mercato. La vera novità è rappresentata dallo scarico abbinato a questo tipo di forma rientrando così nel progetto Water Saving. Un progetto che l'azienda ha intrapreso come vera e propria mission riducendo al minimo i consumi di acqua destinati allo scarico del wc consumandone non più di 3 litri per un ciclo completo.

In line with the new demands of increasing hygiene and basic lines, Azzurra has developed a toilet without flushing rim, which represents a new trend in the current market. The real novelty is in the water release combined with this kind of shape that aims to save water. A project that the company has undertaken as a real mission while minimizing the consumption of flushing water thus consuming no more than 3 litres in a complete cycle.



risparmio
idrico 70%
water saving 70%

pulizia facile
e veloce
easy and fast
cleaning

alto livello
visivo di igiene
high visual
hygienic level



WC NUVOLA
TERRA/TRASLATO
EASY CLEAN 3 lt
FLOOR WC NUVOLA
with 3lt EASY CLEAN
ADJUSTABLE
FLUSH SYSTEM

In linea con le nuove esigenze di una sempre maggior igiene e di linee basiche, AZZURRA propone un wc senza brida, che si inserisce in una nuova tendenza del mercato. La vera novità è rappresentata dallo scarico abbinato a questo tipo di forma rientrando così nel progetto Water Saving. Un progetto che l'azienda ha intrapreso come vera e propria mission riducendo al minimo i consumi di acqua destinata allo scarico del wc consumandone non più di 3 litri per un ciclo completo.

In line with the new demands of increasing hygiene and basic lines, Azurra has developed a toilet without flushing rim, which represents a new trend in the current market. The real novelty is in the water release combined with this kind of shape that aims to save water. A project that the company has undertaken as a real mission while minimizing the consumption of flushing water thus consuming no more than 3 litres in a complete cycle.



NUVOLA

WC EASY CLEAN SCARICO TRASLATO

wc easy clean adjustable flush system



Esempio / Example

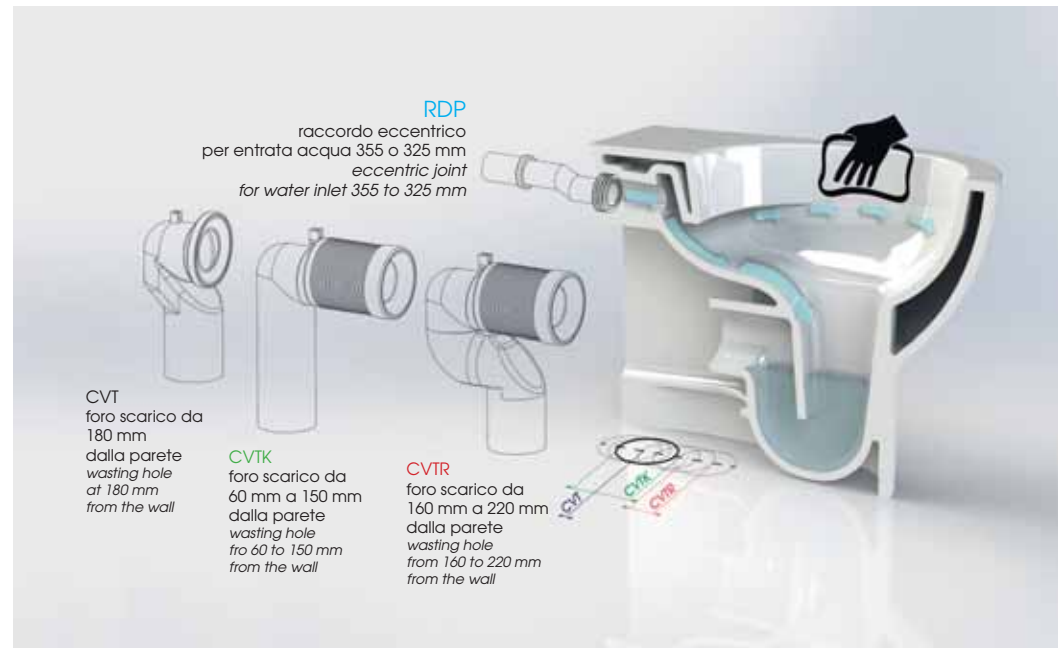

Per ridurre i tempi e i costi di ristrutturazione il centro ricerca Azzurra ha messo a punto, oltre il wc Nuvola, Nuvola H48, Charme, il wc e bidet Tulip, il wc Prua con scarico traslato, anche il wc Pratica con scarico traslato che può essere installato senza dover modificare l'impianto di scarico esistente.

To reduce timing and costs about bathroom renovation Azzurra's research centre has developed, besides Nuvola, Nuvola H48, Charme toilet, Tulip toilet and bidet, Prua toilet with an adaptable outlet, and Pratica toilet with an adjustable outlet which can be installed without modifying the existing outlet system.



01.

01. piatto doccia **PURO** cotone 90x90 cm e bidet a terra NUV 500.
PURO cotton shower tray 90x90 cm and NUV 500 floor bidet.



01.



02.

01. piatto doccia **RELAX** 120x80 bianco lucido / 120x80 **RELAX** shiny white shower tray
Disponibile anche nei colori grigio e nero / Available also in grey and black colors
02. piatto doccia **PURO** 120x80 cotone / 120x80 **PURO** cotton shower tray



01.



02.

01.lavabo NUVOLA 90 bianco **COTONE** / NUVOLA 90 washbasin **COTTON** white.
 02.vaso e bidet Mini NUVOLA bianco **COTTON** / Mini NUVOLA Wc and bidet **COTTON** white.

THIN

angeletti ruzza design

photographer: Paolo Veclani
interiors e styling: Michele Pasini, Storage





I wc terra e sospesi scaricano con soli 3 lt invece dei tradizionali 9 lt.
Floor and wall hung WCS flush with just 3 litres instead of the traditional 9 lt.



Trattamento **antibatterico - antifungo** applicabile su tutti i prodotti in ceramica e copriviassi.
The **antibacterial - antifungal** treatment can be applied to all ceramic products and cover-seats.

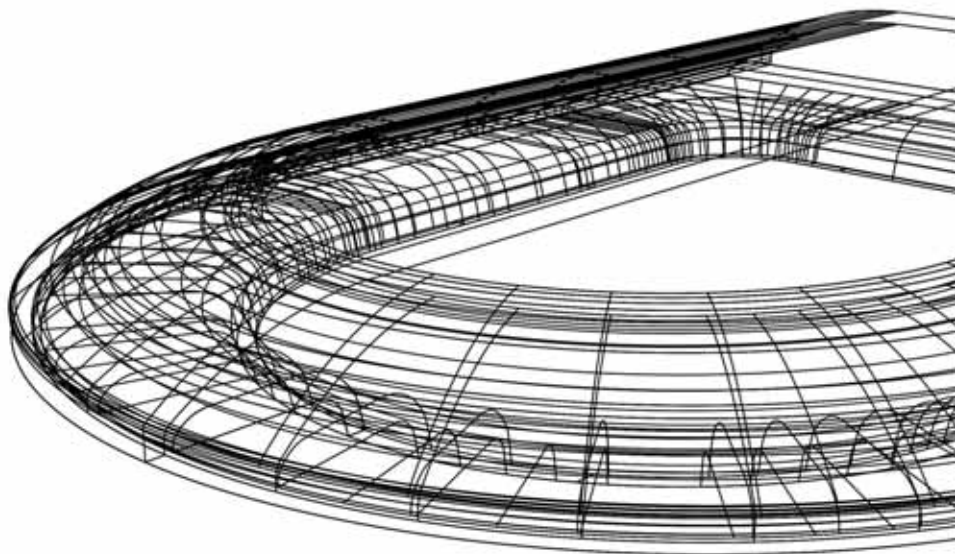

Copriwater THIN/THIN cover seat

Il copriwater thin è espressione di un design basato sulla filosofia della dematerializzazione. I soli 25 mm di altezza totale ne fanno il copriwater avvolgente più sottile al mondo, realizzato in termoplastico. Ridurre la quantità di materia utilizzata oltre a far bene al pianeta ha migliorato l'estetica del prodotto mantenendo inalterate tutte le sue funzionalità. Un'altra importante innovazione AZZURRA che fa della sostenibilità e della ricerca che produce bellezza i suoi valori fondativi.

Thin seat cover is expression of a design based on the philosophy of dematerialization. Its total height of just 25 mm makes it the thinnest wrap around thermosetting seat cover in the world. Reducing the amount of the material used is not only good for the planet, but has improved the look of the product, yet maintaining its functionality. Another important innovation from AZZURRA, which has between its founding values sustainability and research that produces beauty.



copriwater THIN h. 27

THIN cover seat h.27

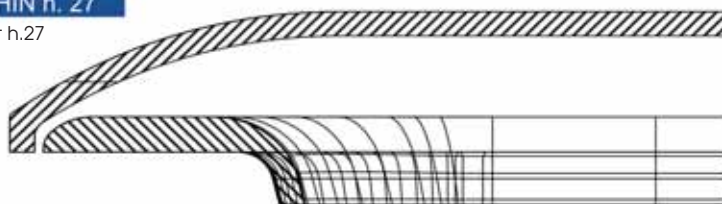

copriwater tradizionale h. 40

Traditional cover seat h.40

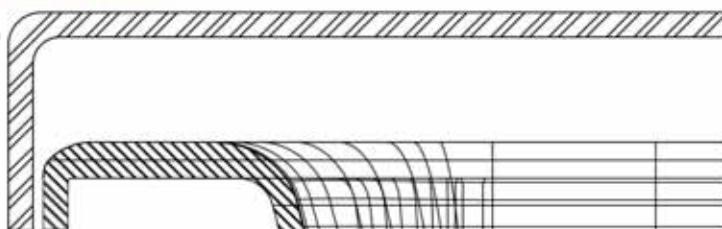

vaso e bidet sospesi THIN, TH1156/SOSK - TH1556/SOSK, miscelatore monocomando bidet LINEA THIN wall-hung wc and bidet TH1156/SOSK - TH1556/SOSK, LINEA single control mixer for bidet



lavabo 75x45 sospeso TH175/SOSP / 60x45 TH160/SOSP wall-hung washbasin.



lavabo 60x45 sospeso TH160/SOSP / 60x45 TH160/SOSP wall-hung washbasin.



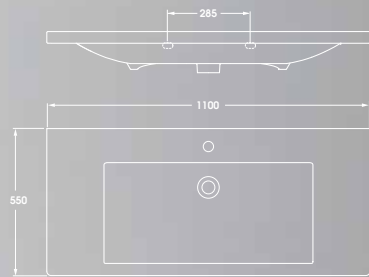

lavabo 110 sospeso TH1 110/SOSP.
TH1 110/SOSP, 110 wall-hung wash basin.



lavabo 120 TH120/SOSP, miscelatore incasso LINEA, specchio NEWS PAPER.
TH120/SOSP 120 washbasin. LINEA Inset single control mixer. NEWS PAPER Mirror

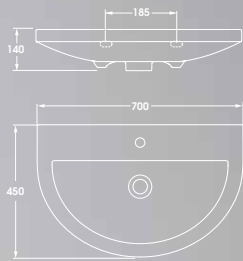

lavabo 60 sospeso THI 260.
THI 260/SOSP, 60 wall-hung wash basin.



01.

02.

01.lavabo incasso cm 60x40 THI 60/IN. THI 60/IN cm 60x40 inset washbasin
02.lavabo incasso cm 75x40 THI 75/IN. THI 75/IN cm 75x40 inset washbasin



lavabo 60 incasso, miscelatore monocomando LINEA.
60 Inset washbasin. LINEA single control mixer



01.



02.



03.

THIN



01.



01. lavabo 70 sospeso THI 200/DIS su meccanismo pneumatico con altezza variabile e barra di comando a leva, rubinetto LINEA AZ L26
 THI 200/DIS 70 wall-hung washbasin on pneumatic mechanism with adjustable height and lever control bar AZ L26 LINEA tap
02. lavabo 70 sospeso THI 200/DIS su staffa inclinazione meccanica con altezza variabile, rubinetto LINEA con leva clinica AZ L26
 THI 200/DIS 70 wall-hung washbasin on mechanic tilt bracket with adjustable height. LINEA Tap with AZ L26 clinical lever
03. lavabo 70 sospeso THI 200/DIS su staffe fisse, rubinetto LINEA con leva clinica AZ L26
 THI 200/DIS 70 wall-hung washbasin on fixed brackets. LINEA tap with AZ L26 clinical lever



02.

4,5 Lt
 scarico d'acqua
 brevettato
 WATER SAVING

01. lavabo 70x57 sospeso THI 200/DIS della collezione THIN diversamente abili
 THI 200/DIS 70x57 THIN wall hung washbasin collection for disabled people
02. vaso sospeso 75x36 THI 100/DIS con copriwater avvolgente termoindurente a chiusura frizionata THI 1848/F
 THI 100/DIS 75x36 wall-hung wc with THI 1848/F wrapping thermosetting cover-seat with soft-closing



vaso e bidet 56 sospesi, miscelatore bidet LINEA AZ 45
56 wall-hung wc and bidet, AZ 45 LINEA mixer for bidet



01.

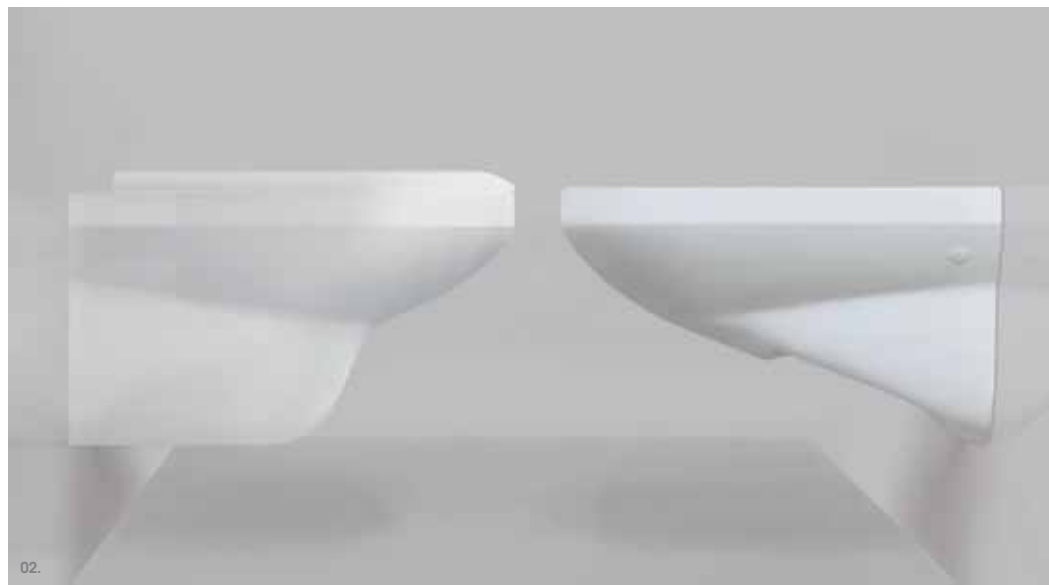

02.

01.vaso sospeso THI 156/SOSK / THI 156/SOSK wall-hung wc
02.vaso 56 sospeso THI 156/SOSK e bidet 56 sospeso THI 556/SOSK / THI 156/SOSK 56 wall-hung bidet and THI 556/SOSK 56 wall-hung bidet



01.



02.

01.piatto doccia **RELAX** 120x80 bianco lucido / 120x80 **RELAX** shiny white shower tray
Disponibile anche nei colori grigio e nero / Available also in grey and black colors
02.piatto doccia **PURO** 120x80 cotone / 120x80 **PURO** cotton shower tray

COMODA
design: OFFICINA AZZURRA

photographer: STUDIO 21





I wc terra e sospesi scaricano con soli 3 lt invece dei tradizionali 9 lt.
Floor and wall hung WCS flush with just 3 litres instead of the traditional 9 lt.



Trattamento **antibatterico - antifungo** applicabile su tutti i prodotti in ceramica e coprivasi.
The **antibacterial - antifungal** treatment can be applied to all ceramic products and cover-seats.



vaso COM 100/P e bidet COM 500 a terra 51,5 cm. Lavabo 80 sospeso COM 80/S.
51,5 cm floor mounted wc COM 100/P and bidet COM 500. COM 80/S 60 wall-hung washbasin.



lavabo appoggio CIRCLE cm 60x40 ECI 60. Rubinetteria LINEA cromo, mensola MISURA.
ECI 60 cm 60x40 over counter washbasin. LINEA chromed taps, MISURA shelf.



01. lavabo appoggio CIRCLE cm 40x40 ECI 40. ECI 40 cm 40x40 over counter washbasin.
02. lavabo appoggio CIRCLE cm 60x40 ECI 60. ECI 60 cm 60x40 over counter washbasin.
03. lavabo appoggio CIRCLE cm 70x42 ECI 70. ECI 70 cm 70x42 over counter washbasin.
04. lavabo appoggio CIRCLE cm 90x44 ECI 90. ECI 90 cm 90x44 over counter washbasin.



Dimensioni disponibili / Available dimensions
lavabo sospeso COM 55/S cm 55 monoforo. COM 55/S CM 55 one hole wall.hung washbasin.
lavabo sospeso COM 65/S cm 65 monoforo. COM 65/S CM 65 one hole wall.hung washbasin.
lavabo sospeso COM 80/S cm 80 monoforo. COM 80/S CM 80 one hole wall.hung washbasin.



lavabo sospeso COM 80/S cm 80 monoforo. COM 80/S CM 80 one hole wall.hung washbasin.



vaso COMODA terra COM 100/P con bidet COMODA terra COM 500, Rubinetteria LINEA COM 100/P wall-hung wc with COM 500 wall-hung one-hole bidet. LINEA taps





vaso COMODA sospeso COM 100/SOSP con bidet COMODA sospeso COM 500/SOSP. Rubinetteria LINEA
 COM 100/SOSP wall-hung wc with COM 500/SOSP wall-hung one-hole bidet. LINEA taps



VERA

angeletti ruzza design

photographer: Paolo Veciani
interiors e styling: Michele Pasini, Storage
photographer: Studio 21





I wc terra e sospesi scaricano con soli 3 lt invece dei tradizionali 9 lt.
Floor and wall hung WCS flush with just 3 litres instead of the traditional 9 lt.



Trattamento **antibatterico - antifungo** applicabile su tutti i prodotti in ceramica e copriviassi.
The **antibacterial - antifungal** treatment can be applied to all ceramic products and cover-seats.



lavabo CIRCLE cm 70 in appoggio su mensola cm 170 laccata bianco lucida
cm 70 CIRCLE washbasin on cm 170 lacquered shiny white counter top.

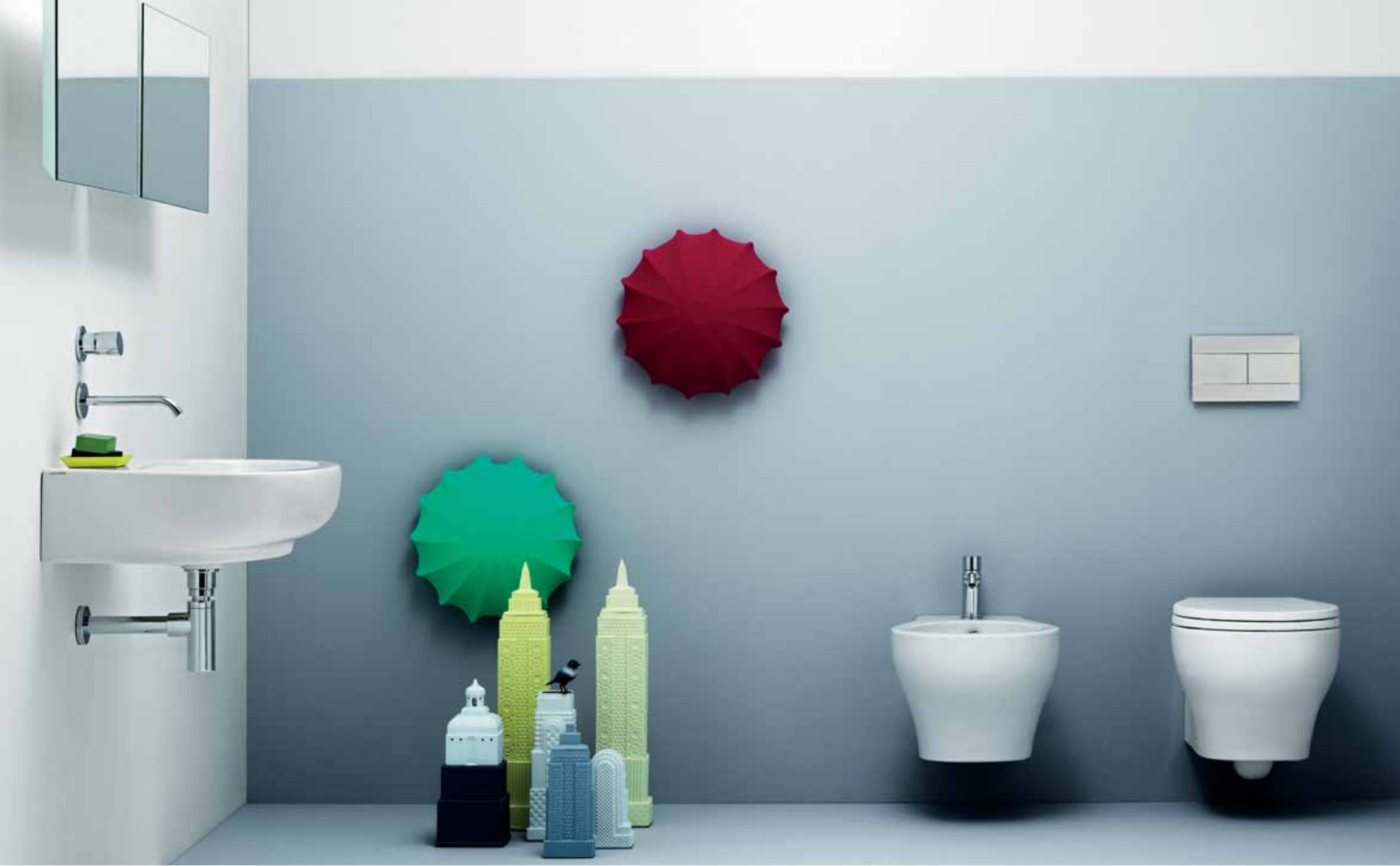

vaso VERA sospeso VER 100/SOSK con bidet VERA sospeso VER 500/SOSK. Rubinetteria LINEA
VER 100/SOSK wall-hung wc with VER 500/SOSK wall-hung one-hole bidet. LINEA taps

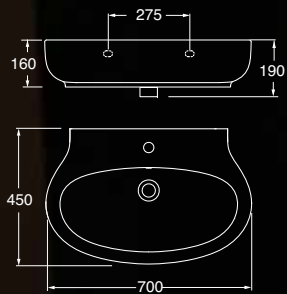

lavabo sospeso 60 VER 60/SOSP.
 Disponibile nelle dimensioni 70x45 VER 70/SOSP e 60x45 VER 60/SOSP.
 VER 70/SOSP wall-hung washbasin.
 Available on dimensions 60x45 VER 60/SOSP and 70x45 VER 70/SOSP.



01. lavabo appoggio CIRCLE cm 40x40 ECI 40. ECI 40 cm 40x40 over counter washbasin.
 02. lavabo appoggio CIRCLE cm 60x40 ECI 60. ECI 60 cm 60x40 over counter washbasin.
 03. lavabo appoggio CIRCLE cm 70x42 ECI 70. ECI 70 cm 70x42 over counter washbasin.
 04. lavabo appoggio CIRCLE cm 90x44 ECI 90. ECI 90 cm 90x44 over counter washbasin.



lavabi appoggio CIRCLE EC140 / EC190, vaso e bidet terra VERA VER 155/VER 555.
EC140 / EC190 CIRCLE washbasin, VER 155/VER 555 VERA wc and bidet.

Mensola laccata bianca ME 170 B. Specchi NEWS PAPER THS 58 D, rubinetteria LINEA.
ME 170 B lacquered polish white shelf. NEWS PAPER THS 58 D mirrors, LINEA mixer.





vaso VERA a terra VER 148/P con bidet VERA a terra VER 548
VER 148/P wc with VER 548 bidet.



lavabo sospeso 70 VER 70/SOSP. Vaso VERA sospeso VER 100/SOSK con bidet VERA sospeso VER 500/SOSK.
VER 70/SOSP wall-hung washbasin. VER 100/SOSK wall-hung wc with VER 500/SOSK wall-hung one-hole bidet.

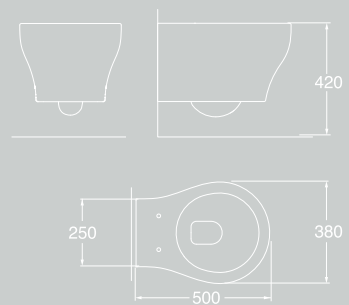

vaso e bidet VERA sospesi VER 100/SOSK VER 500/SOSK
 VER 100/SOSK VER 500/SOSK wc and bidet wall-hung VERA



vaso e bidet VERA terra mini VER 148/P VER 548
 VER 148/P VER 548 wc and bidet VERA



GLAZE

design: Gordon Guillaumier

photographer: Paolo Veciani
interiors e styling: Michele Pasini, Storage





I wc terra e sospesi scaricano con soli 3 lt invece dei tradizionali 9 lt.
Floor and wall hung WCS flush with just 3 litres instead of the traditional 9 lt.



Trattamento **antibatterico** - **antifungo** applicabile su tutti i prodotti in ceramica e copriviassi.
The **antibacterial** - **antifungal** treatment can be applied to all ceramic products and cover-seats.



lavabo appoggio cm 60 GLZ 260/APP su mobile in walnut
GLZ 260/APP cm 60 over-counter washbasin on furniture walnut finishing



vaso e bidet sospesi cm 52 GLZ 100/SOSK - GLZ 500/SOSK. Lavabo sospeso cm 75 GLZ 275/SOSP, rubinetteria LINEA.



GLZ 100/SOSK - GLZ 500/SOSK cm 52 wall hung wc and bidet. GLZ 275/SOSP cm 75 wall hung washbasin, LINEA taps.

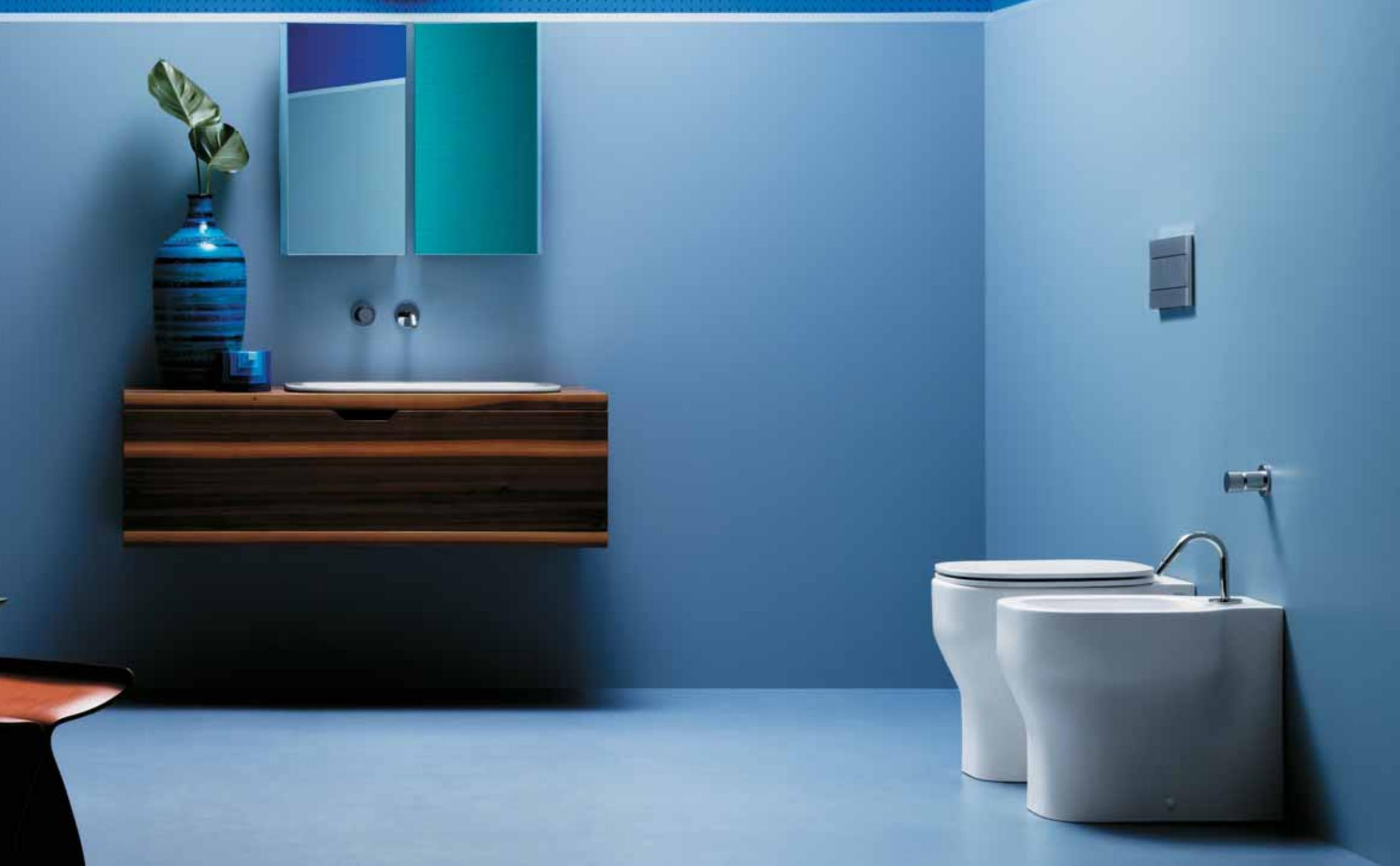

vaso e bidet terra cm 52. GLZ 100 - GLZ 500. Lavabo incasso cm 70 GLZ 69x38/IN. Mobile con anta a ribalta unica in walnut, rubinetteria LINEA, specchio MIRROR BOOK.

GLZ 100 - GLZ 500 cm 52 floor wc and bidet. GLZ 69x38/IN cm 70 inset washbasin. Furniture with single drop-leaf drawer, walnut finishing, LINEA taps, MIRROR BOOK mirror.





Lavabo sospeso cm 60 cod. GLZ 260 , vaso e bidet terra cod. GLZ 100 - GLZ 500, specchio Mirror Book, rubinetteria LINEA
 Cod. GLZ 260 cm 60 wall-hung washbasin, GLZ 100 – GLZ 500 floor standing WC and bidet, Mirror Book mirror, LINEA taps



01.



02.

01.lavabo appoggio cm 60 cod. GLZ 60 /APP, rubinetteria LINEA / cod. GLZ 60/APP cm 60 over counter washbasin, LINEA taps
 02.lavabo sospeso cm 75 GLZ 275/ SOSP, rubinetteria LINEA / GLZ 275/SOSP cm 75 wall hung washbasin, LINEA taps



01.



02.



03.

01.lavabo appoggio cm 60 GLZ 260/APP. GLZ 260/APP cm 60 over-counter washbasin
02.lavabo incasso cm 50 GLZ 50x40/IN GLZ 50x40/IN cm 50 inset washbasin
03.lavabo incasso cm 70 GLZ 69x38/IN GLZ 69x38/IN cm 70 inset washbasin



lavabo sottopiano cm 69 GLZ 69x38/SP. Mobile sospeso con anta a ribalta unica in walnut. Specchio MIRROR BOOK. Rubinetteria LINEA GLZ 69x38/SP cm 69 inset washbasin. Wall hung furniture with single drop-leaf drawer, walnut finishing. Mirror MIRROR BOOK. LINEA taps

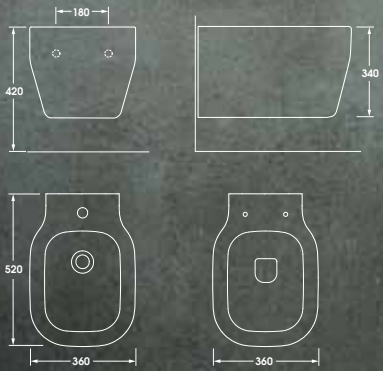

vasi e bidet sospesi cm 52 GLZ 100/SOSK - GLZ 500/SOSK, rubinetteria LINEA
GLZ 100/SOSK - GLZ 500/SOSK cm 52 wall hung wc and bidet, LINEA taps





01.

01.vaso e bidet terra cm 52 GLZ 100 - GLZ 500, rubinetteria LINEA
GLZ 100 - GLZ 500 cm 52 floor wc and bidet, LINEA taps



02.

02.vaso monoblocco cm 66 GLZ 110/MBP, cassetta monoblocco GLZ 400 MBL
GLZ 110/MBP cm 66 close-coupled wc, GLZ 400 MBLclose coupled cistern



CULT

design: OFFICINA AZZURRA

photographer: Paolo Veclani
interiors e styling: Michele Pasini, Storage





I wc terra e sospesi scaricano con soli 3 lt invece dei tradizionali 9 lt.
Floor and wall hung WCS flush with just 3 litres instead of the traditional 9 lt.



Trattamento **antibatterico** - **antifungo** applicabile su tutti i prodotti in ceramica e copriviassi.
The **antibacterial** - **antifungal** treatment can be applied to all ceramic products and cover-seats.



TR 8141 consolle 81 CULT sospeso
TR 8141 81 CULT wall-hung console washbasin



lavabo CULT monoforo sospeso XCU 200/64; bidet sospeso 51 cm XCU 500/SOSP - Wc sospeso 51 cm XCU 100/SOSP
XCU 200/64 CULT washbasin one-hole wall hung; XCU 500/SOSP 51 wall hung bidet - XCU 100/SOSP 51 wall hung Wc





TR 7141 consolle 71 sospesa monoforo
TR 7141 71 console wall hung one hole washbasin



01.



02.



03.



04.

01. TR 10141 consolle 101 sospesa monoforo; TR 8141 consolle 81 sospesa monoforo / TR 10141 101 console wall hung one hole;
TR 8141 81 console wall hung one hole washbasin
02. TR 7141 consolle 71 sospesa monoforo / TR 7141 71 console wall hung one hole washbasin
03. XCU 200/64 lavabo sospeso monoforo / XCU 200/64 wall-hung one hole washbasin
04. TR 8141 consolle 81 sospesa monoforo con portasciugamani in ottone cromato TR PU/75 / TR 8141 81 console wall hung one hole washbasin
with TR PU/75 chromed brass towel holder



01.



02.

01.vaso terra 51 cm XCU 100/P - XCU 100/S con bidet terra 51 cm XCU 500
XCU 100/P - XCU 100/S 51 floor wc with XCU 500 51 floor one-hole bidet
02.bidet sospeso 51 cm XCU 500/SOSP - Wc sospeso 51 cm XCU 100/SOSP
XCU 500/SOSP 51 wall hung bidet - XCU 100/SOSP 51 wall hung Wc



PRATICA
OFFICINA AZZURRA

photographer: Studio 21





I wc terra e sospesi scaricano con soli 3 lt invece dei tradizionali 9 lt.
Floor and wall hung WCS flush with just 3 litres instead of the traditional 9 lt.



Trattamento **antibatterico - antifungo** applicabile su tutti i prodotti in ceramica e copriviassi.
The **antibacterial - antifungal** treatment can be applied to all ceramic products and cover-seats.



lavabo sospeso PRA200 cm 64,5
PRA200 cm 64,5 wall-hung washbasin



lavabo sospeso cm 64,5 PRA200, vaso e bidet sospesi 52,5x35, rubinetteria LINEA.
PRA200 cm 64,5 wall-hung washbasin, cm 52,5x35 wall hung Wc and bidet, LINEA taps.





lavabo su colonna, rubinetteria LINEA / washbasin on pedestal, LINEA taps



01.



02.



03.

01.02 lavabo PRATICA su colonna, rubinetteria LINEA / PRATICA washbasin on pedestal, LINEA taps
02. lavabo PRATICA sospeso, rubinetteria LINEA/ PRATICA washbasin wall hung, LINEA taps



vaso e bidet PRATICA filo muro PRA110 - PRA510, rubinetteria LINEA/ PRATICA PRA110 - PRA510 Wc and bidet back to wall, LINEA taps



01.



02.



03.

01. bidet PRATICA PRA510, rubinetteria LINEA / PRATICA PRA510 bidet, LINEA taps
 02. wc monoblocco PRATICA PRA100MBL / PRATICA PRA100MBL close coupled wc
 03. vaso e bidet PRATICA sospesi PRA100/SOSP - PRA 500/SOSP, rubinetteria LINEA
 PRATICA PRA100/SOSP - PRA 500/SOSP wall hung Wc and bidet, LINEA taps





vaso e bidet PRATICA filo muro PRA110 - PRA510/ PRATICA PRA110 - PRA510 Wc and bidet back to wall



01.



02.



03.



01. bidet PRATICA PRA510, rubinetteria LINEA / PRATICA PRA510 bidet, LINEA taps
 02. vaso/bidet PRATICA PRA 110 BI (disponibile da giugno 2016) / PRATICA PRA 110 BI wc/bidet (available from june 2016)
 03. wc terra PRATICA EASY CLEAN TRASLATO PRA100E/TR / PRATICA EASY CLEAN floor trap wc adjustable flush system.





PRATICA

WC EASY CLEAN 3 Lt scarico traslato

wc easy clean 3 lt adjustable flush system



Esempio / Example



 **risparmio idrico 70%**
water saving 70%

 **pulizia facile e veloce**
easy and fast cleaning

 **alto livello visivo di igiene**
high visual hygienic level

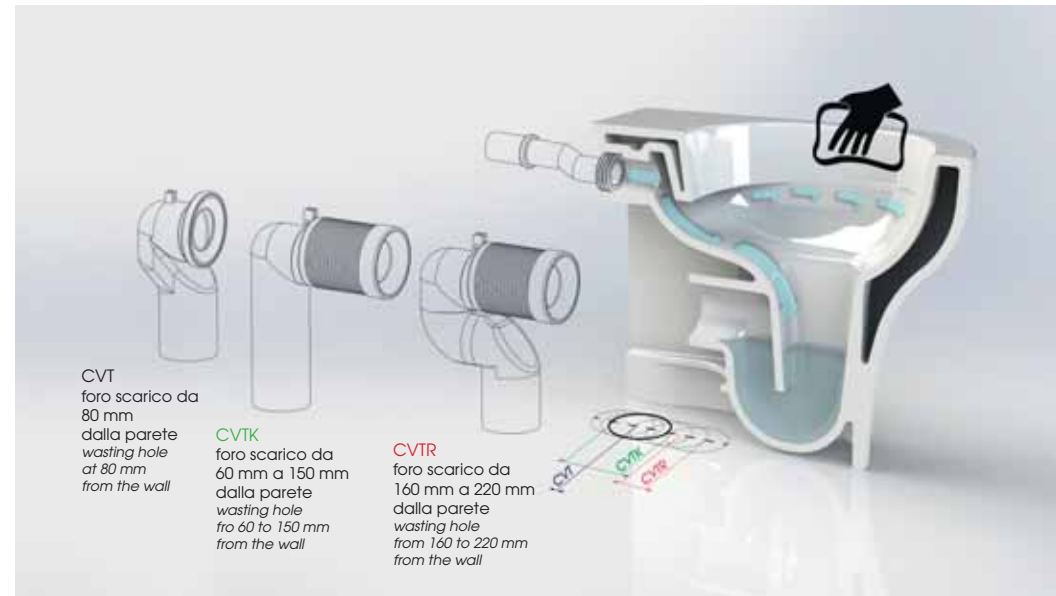

CVT
foro scarico da 80 mm dalla parete
wasting hole at 80 mm from the wall

CVTK
foro scarico da 60 mm a 150 mm dalla parete
wasting hole fro 60 to 150 mm from the wall

CVTR
foro scarico da 160 mm a 220 mm dalla parete
wasting hole from 160 to 220 mm from the wall

* CVT	CVTK	CVTR	* RDP
da 180 mm	da 60 mm a 150 mm	da 160 mm a 220 mm	mm 355 o mm 325

In linea con le nuove esigenze di una sempre maggior igiene e di linee basiche, AZZURRA propone un wc senza brida con tecnologia Water Saving, che si inserisce in una nuova tendenza del mercato.

In line with the new demands of increasing hygiene and basic lines, AZZURRA has developed a toilet without flushing rim and Water Saving technology.

Per ridurre i tempi e i costi di ristrutturazione il centro ricerca Azzurra ha messo a punto, oltre il wc Nuvola, Nuvola H48, Charme, il wc e bidet Tulip, il wc Prua con scarico traslato, anche il wc Pratica con scarico traslato che può essere installato senza dover modificare l'impianto di scarico esistente.

To reduce timing and costs about bathroom renovation Azzurra's research centre has developed, besides Nuvola, Nuvola H48, Charme toilet, Tulip toilet and bidet, Prua toilet with an adaptable outlet, and Pratica toilet with an adjustable outlet which can be installed without modifying the existing outlet system.

CHARME

design: Laudani & Romanelli
con Giorgio Bonaguro
Juan Soriano Blanco

photographer: Sebastiano Luciano





1 wc terra e sospesi scaricano con soli 3 lt invece dei tradizionali 9 lt.
Floor and wall hung WCS flush with just 3 litres instead of the traditional 9 lt.



Trattamento **antibatterico - antifungo** applicabile su tutti i prodotti in ceramica e copriviassi.
The **antibacterial - antifungal** treatment can be applied to all ceramic products and cover-seats.



lavabo CHARME cm 70 CHA 270 monoforo sospeso, Rubinetteria LINEA cm 70 CHARME wall-hung one-hole washbasin CHA 270. LINEA taps



lavabo sospeso cm 55 CHA 255, vaso e bidet sospesi cm 52 CHA 500 SOSK/CHA 100 SOSK. Platto uniKo cm H3.
Specchio MIRROR BOOK
cm 55 CHA 255 wall-hung washbasin, cm 52 CHA 500 SOSK/CHA 100 SOSK wall-hung wc and bidet. uniKo shower tray cm H3.
MIRROR BOOK mirror





lavabo tondo cm 70 CHA 270 con colonna CHA 300, vaso e bidet a terra cm 52 CHA 500/CHA 100/P. Specchio MIRROR BOOK, rubinetteria LINEA
cm 70 CHA 270 round washbasin with pedestal CHA 300, cm 52 CHA 500/CHA 100/P wc and bidet. MIRROR BOOK mirror, LINEA taps





lavabo tondo cm 70 CHA 270 con struttura in ottone bianco lucido cm 70 CHAST 70. Specchio ellittico con molatura Victorian Style cm 55x115.
cm 70 CHA 270 round washbasin with cm 70 CHAST 70 chromed brass structure shiny white. cm 55x115 Victorian style elliptical mirror with grinding.



01.



02.



03.

01. lavabo sospeso cm 90 CHA 290 / cm 90 CHA 290 wall-hung washbasin.
02. lavabo sospeso cm 68 CHA 268 / cm 68 CHA 268 wall-hung washbasin.
03. vaso sospeso cm 52 CHA 100 SOSK e bidet sospeso cm 52 CHA 500 SOSK, lavabo sospeso cm 55 CHA 255, piatto UniKo cm H3.
cm 52 CHA 100 SOSK wall-hung Wc and cm 52 CHA 500 SOSK wall-hung bidet, cm 55 CHA 255 wall-hung washbasin, UniKo shower tray cm H3.



01.

02.

03.

01.lavabo cm 55 CHA255 sospeso/appoggio. CHA255 cm 55 wall-hung/over counter washbasin.
 02.lavabo cm 68 CHA268 sospeso/appoggio. CHA268 cm 68 wall-hung/over counter washbasin.
 03.lavabo cm 90 CHA290 sospeso/appoggio. CHA290 cm 90 wall-hung/over counter washbasin.



lavabo CHARME cm 68 su mobile 170 laccato bianco opaco. Rubinetteria LINEA, specchio mirror book.
 CHARME 68 cm washbasin on 170 wall hung lacquered matt white furniture. LINEA taps and mirror book.



01.



02.

01.lavabo appoggio cm 45 JUB45/APP / JUB45/APP cm 45 over-counter washbasin
02.lavabo appoggio cm 50 JUB50/APP / JUB50/APP cm 50 over-counter washbasin



01.



02.

i lavabi appoggio JUB45/APP e JUB50/APP sono disponibili anche nella finitura CORTECCIA e nero lucido.
JUB45/APP and JUB50/APP over-counter washbasins are also available in CORTECCIA finishing and shiny black finishing.



vaso sospeso cm 52 CHA 100 SOSK e bidet sospeso cm 52 CHA 500 SOSK.
cm 52 CHA 100 SOSK wall-hung Wc and cm 52 CHA 500 SOSK wall-hung bidet.



vaso sospeso cm 52 CHA 100 SOSK e bidet sospeso cm 52 CHA 500 SOSK. Rubinetteria LINEA
cm 52 CHA 100 SOSK wall-hung Wc and cm 52 CHA 500 SOSK wall-hung bidet. LINEA taps





01.



02.



03.

01. vaso sospeso cm 52 CHA 100 SOSK e bidet sospeso cm 52 CHA 500 SOSK / cm 52 CHA 100 SOSK wall-hung Wc and cm 52 CHA 500 SOSK wall-hung bidet.

02. vaso monoblocco CHA 100/MBP con scarico a parete trasformabile a pavimento / Wall trap close coupled WC convertible into floor trap.

03. vaso a terra CHA 100 con cassetta a zaino CHA 400 Z/ CHA 100 wc floor mounted with low-level cistern with cover.



vaso a terra cm 52 CHA 100/P e bidet a terra cm 52 CHA 500, rubinetteria LINEA cm 52 CHA 100/P WC and cm 52 CHA 500 bidet, LINEA taps



bidet a terra cm 52 CHA 500, vaso monoblocco CHA 100/MBP, rubinetteria LINEA cm 52 CHA 500 bidet, CHA 100/MBP close coupled WC, LINEA taps



lavabo CHARME cm 68 sospeso. Rubinetteria LINEA, bidet a terra cm 52 CHA 500, vaso a terra CHA 100 con cassetta alta CHA 400 C
CHARME 68 cm wall-hung washbasin. LINEA taps and mirror book, cm 52 bidet CHA 500, wc floor mounted CHA 100 with high-level cistern

CHARME

WC SCARICO TRASLATO

wc adjustable flush system



Esempio / Example

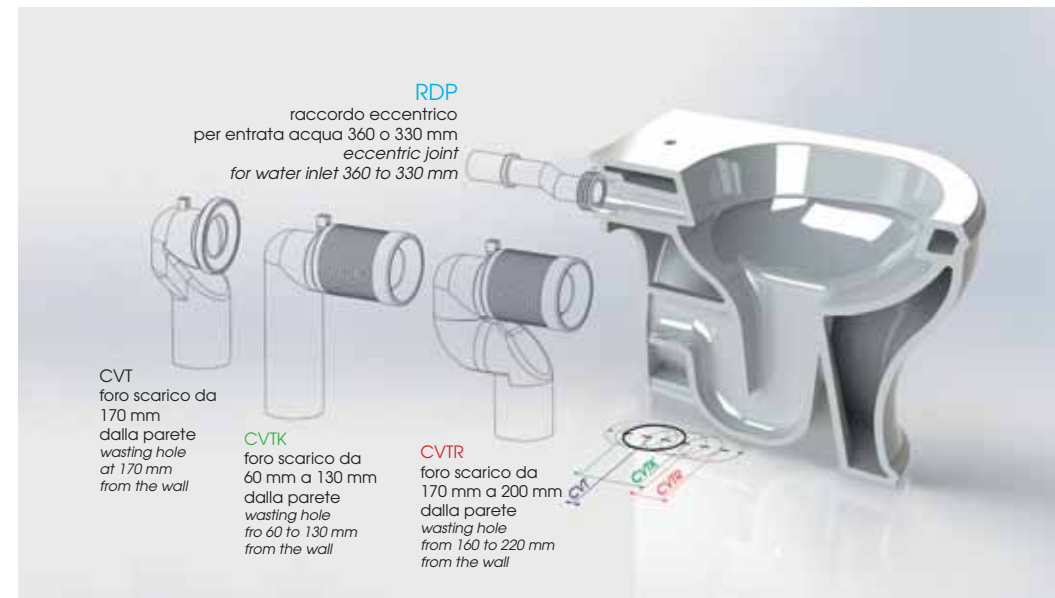

vaso a terra cm 52 CHA 100/TR SCARICO TRASLATO a pavimento, rubinetteria LINEA cm 52 CHA 100/P floor trap WC with adjustable flush system, LINEA taps

Per ridurre i tempi e i costi di ristrutturazione il centro ricerca Azzurra ha messo a punto, oltre il wc Nuvola, Nuvola H48, Charme, il wc e bidet Tulip, il wc Prua con scarico traslato, anche il wc Pratica con scarico traslato che può essere installato senza dover modificare l'impianto di scarico esistente.

To reduce timing and costs about bathroom renovation Azzurra's research centre has developed, besides Nuvola, Nuvola H48, Charme toilet, Tulip toilet and bidet, Prua toilet with an adaptable outlet, and Pratica toilet with an adjustable outlet which can be installed without modifying the existing outlet system.

VICTORIAN STYLE

design: OFFICINA AZZURRA

photographer: Paolo Veciani
interiors e styling: Michele Pasini, Storage



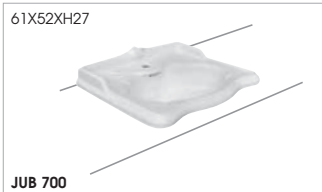

JUB 700



JUB 45/APP



JUB 510



GIU 200 110/ALZA



V112 B



JUB 200/50



JUB 35/AN



JUB 100/MBS

46x22 JUB 400/MBL



GIU 100/P



V113 B



JUB 200/60



JUB 100/SOSK

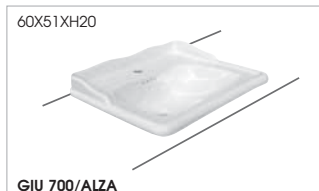

GIU 700/ALZA



GIU 500/M



JUB 200



JUB 500/SOSK



GIU 200 58/ALZA



GIU 100/MBS

GIU 100/MBP

39X19 GIU 400/MBL



JUB 200/90



JUB 100/P



GIU 200 68/ALZA



JUB 200/110



JUB 500/P



GIU 200/ALZA



JUB 50/APP



JUB 110/P



ANT 200



1 wc terra e sospesi scaricano con soli 3 lt invece dei tradizionali 9 lt.
Floor and wall hung WCS flush with just 3 litres instead of the traditional 9 lt.



Trattamento antibatterico - antifungo applicabile su tutti i prodotti in ceramica e coprivasi.
The antibacterial - antifungal treatment can be applied to all ceramic products and cover-seats.



lavabo Jubilæum 61 sospeso JUB 200/60 . wc e bidet sospesi. rubinetteria 3 fori collezione LINEA.

JUB 200/60 61 Jubilæum wall-hung washbasin. wall-hung wc and bidet. LINEA collection three holes taps and fittings.





consolle Jubilaeum 91 su struttura in metallo cromato, vasca in crystaltech con piedini cromati, wc e bidet a terra filo muro, rubinetteria collezione LINEA. Specchio ellittico con molatura cm 115x55.

91 Jubilaeum console on chromed metal structure, bath-tub with chromed feet, floor WC and bidet, LINEA collection taps and fittings. Elliptical mirror with grinding 115x55 cm.



consolle Jubilaeum 110 monoforo JUB 200/110. Mobile laccato nero lucido VM 110/NELU e maniglie con inserti SWAROVSKI, rubinetteria LINEA cm 100 JUB 200/110 Jubilaeum one-hole consolle. Lacquered shiny black furniture and handles with SWAROVSKI insert, LINEA taps.



01.



02.



03.

01.lavabo jubilaeum angolo 35x35 sospeso senza foro predisposto per foro JUB 35/AN
JUB 35/AN 35x35 Jubilaeum corner wall-hung - arranged washbasin tap hole on request
02.colonna JUB 300 / JUB 300 pedestal
03.consolle 110 monoforo GIU 200110/ALZAT. Mobile sospeso laccato nero lucido VM 110/NELU e maniglie con inserti SWAROVSKI, rubinetteria LINEA cm 100 GIU 200110/ALZAT one-hole consolle. Lacquered shiny black furniture and handles with SWAROVSKI insert, LINEA taps.
04.lavabo jubilaeum 60 monoforo JUB 200/60 su struttura in metallo cromato V50
JUB 200/60 60 Jubilaeum wall-hung one-hole washbasin sit on V50 chromed metal structure



04.



01.lavabo ANGOLO JUB35AN, rubinetteria LINEA / CORNER JUB35AN washbasin, LINEA taps



01.lavabo appoggio JUB50APP / JUB50APP over-counter washbasin



01.lavabo appoggio JUB45APP / JUB45APP over-counter washbasin



vaso e bidet sospeso nero corteccia JUB 100/sosk - JUB 500/sosk, rubinetteria LINEA JUB 100/sosk - JUB 500/sosk black corteccia wall-hung WC and bidet, LINEA taps



01.



02.



03.



04.

01.vaso Jubilaeum con sedile avvolgente in termoindurente JC 1800TI / Jubilaeum wc JC 1800TI wrapping thermosetting cover-seat
 02.vaso a terra jubilaeum JUB 100/P - JUB 100/S con coprivaso in poliestere JC 1800, bidet a terra 3 fori JUB 500/M, gruppo bidet 3 fori collezione LINEA JUB 100/p - JUB 100/S Jubilaeum floor wc with JC 1800 polyester cover-seat, JUB 500/M floor 3 holes bidet, LINEA collection 3 holes bidet set
 03.bidet sospeso Jubilaeum monoforo JUB 500/SOSK / JUB 500/SOSK Jubilaeum wall-hung one-hole bidet
 04.vaso Jubilaeum filo muro con sedile avvolgente in termoindurente JC 1800TI / Jubilaeum wc walltrap JC 1800TI wrapping thermosetting cover-seat



vaso e bidet sospesi JUB 100/sosk - JUB 500/sosk, consolle cm 110 JUB 200/110, mobile sospeso laccato nero lucido VMS 110/NELU
 JUB 100/sosk - JUB 500/sosk wall-hung WC and bidet, JUB 200/110 cm. 110 console, VMS 110/NELU wall-hung lacquered shiny black furniture



vaso monoblocco JUBILAEUM JUB 100MBS
 JUBILAEUM JUB 100MBS close coupled wc



consolle jubileum 110 su mobile laccato nero e maniglie con inserti SWAROVSKI. vaso con cassetta a zaino. rubinetteria 3 fori collezione LINEA. Specchio ellittico con molatura cm 85x45.

110 Jubilaum console sit on black matt lacquered furniture and handles with swarovsky inset. wc with low-level cistern. LINEA collection 3 holes taps and fittings. Elliptical mirror with grinding 85x45 cm.



01.

01.lavabo giunone 76x59 monoforo GIU 200/ALZA su colonna GIU 300/76.
Disponibile nelle dimensioni 60x51 GIU 700/ALZA; 68x53 GIU 200 68/ALZA e 76x59 GIU 200/ALZA
GIU 200/ALZA 76x59 Giunone one-hole washbasin sit on GIU 300/76 pedestal
Available on dimensions 60x51 GIU 700/ALZA; 68x53 GIU 200 68/ALZA e 76x59 GIU 200/ALZA



02.



03.

02.consolle antea 96 monoforo ANT 200 su struttura in metallo cromato V100
ANT 200 96 ANTEA one-hole console sit on V100 chromed metal structure
03.consolle giunone 110 monoforo GIU 200110/ALZA su mobile laccato nero opaco VM110/NERO.
maniglie con inserti SWAROVSKI. gruppo 3 fori collezione LINEA. Specchio ellittico con molatura cm 85x45.
GIU 200110/ALZA Giunone 110 one-hole console sit on VM110/nero black matt lacquered furniture
and handles with SWAROVSKI inset. Elliptical mirror with grinding 85x45 cm.





bidet giunone 3 fori, gruppo bidet collezione LINEA, wc terra con cassetta a zaino GIU 400/Z, coprivaso in poliestere bianco GC 1800
 Giunone three-holes bidet, LINEA collection taps and fittings for bidet floor wc with low-level cistern, GC 1800 white polyester cover-seat



01.



02.



03.

01.vaso giunone con scarico a parete GIU 100/P con sedile avvolgente in termoindurente GC1800 TI. bidet monoforo GIU 500/M, bidet 3 fori GIU 500/T
 GIU 100/P Giunone wall-trap wc with GC 1800TI wrapping thermosetting cover-seat: GIU 500/M one hole bidet, GIU 500/T 3 holes bidet
 02.vaso monoblocco giunone con scarico a pavimento GIU 100/MBS e cassetta monoblocco GIU 400/MBL
 GIU 100/MBS Giunone wall-trap close coupled wc with GIU 400/MBL close coupled cistern
 03.vaso giunone scarico a pavimento GIU 100/MBS con coprivaso in poliestere GC 1800
 GIU 100/MBS Giunone wall-trap wc with GC 1800 polyester cover-trap



01.

01.vasca victorian in crystaltech V 112 B. gruppo vasca esterno collezione LINEA.
V 112 B Victorian crystaltech bathtub. LINEA collection.



01.

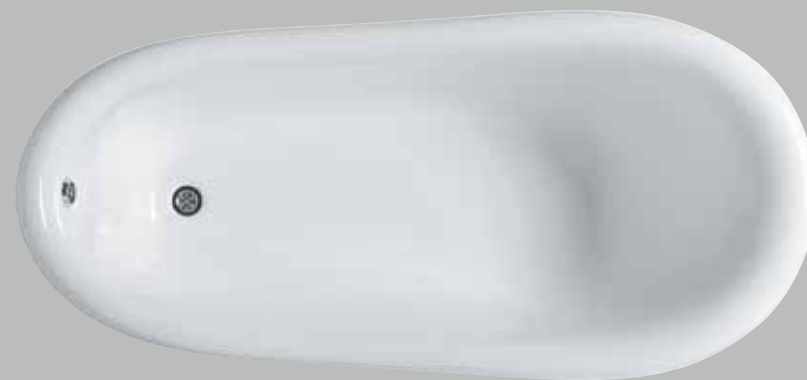

02.



01.vasca victorian in crystaltech V 113B completa di colonna di scarico e piedi cromati
V 113B B Victorian crystaltech bathtub provided with drainage system and feet in chrome finishing
02.vasca victorian in crystaltech V 112B completa di colonna di scarico e piedi cromati o bianchi
V 112B B Victorian crystaltech bathtub provided with drainage system and feet in chrome or white finishing

ELEGANCE

OFFICINA AZZURRA

photographer: Studio21

Da sempre attenta a raggiungere nuovi traguardi nella lavorazione della ceramica sanitaria, AZZURRA propone una serie di lavabi dallo spessore minimo di 3 mm. Le forme di Elegance si allineano alle tendenze attuali del mondo del bagno, in cui spesso però vengono utilizzati materiali alternativi, perdendo quindi la grande potenzialità della ceramica, che AZZURRA continua a mantenere come cardine della sua produzione.

Always attentive to achieve new targets in the ceramic production, AZZURRA offers a range of washbasins with a minimum thickness of 3 mm. Elegance shapes are in line with current trends in the world of the bathroom furnishing, in which, however, alternative and non traditional materials are often used, thus losing the great potential of ceramic, a material which AZZURRA keeps using as a foundation of its production.

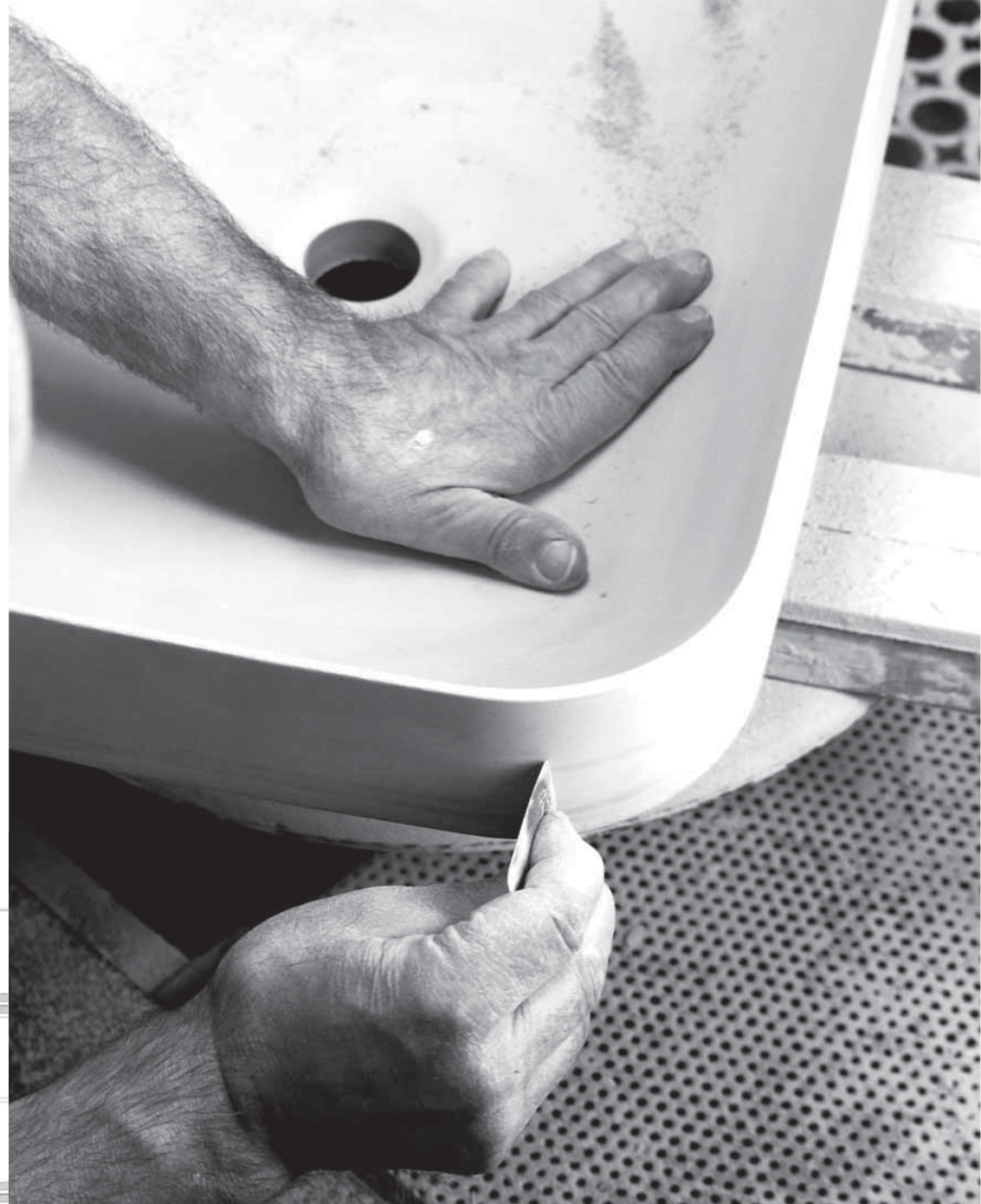
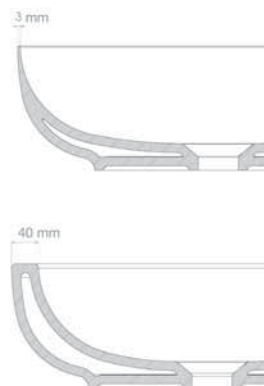

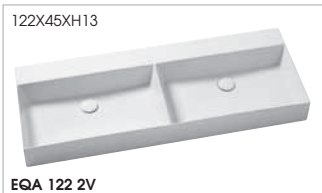

COLORS 1250°



 Piletta con tappo in ceramica disponibile in tutti i COLORS 1250°
Free flow ceramic drain available in all COLORS 1250°
cod. **PILCE**
kg 0,5



Trattamento **antibatterico - antifungo** applicabile su tutti i prodotti in ceramica e copriviasi.
The **antibacterial - antifungal** treatment can be applied to all ceramic products and cover-seats.



COLORS1250° FOR ELEGANCE



Azzurra propone i lavabi Elegance Colors1250° anche in abbinamento alla nuovissima mensola Misura che, attraverso un gioco di total color, rende possibile un elegante e, appunto, totale allineamento cromatico tra lavabo e supporto. Realizzata in ceramica ha uno spessore di soli 3 cm ed è realizzabile su misura.

Azzurra offers Elegance washbasins Colors1250° also in combination with the new shelf Measure, giving a total chromatic alignment between the basin and its support. The ceramic shelf, comes in a thickness of only 3 cm and is made to measure.



01. lavabo appoggio CIRCLE cm 40x40 ECI 40. ECI 40 cm 40x40 over counter washbasin.
 02. lavabo appoggio CIRCLE cm 60x40 ECI 60. ECI 60 cm 60x40 over counter washbasin.
 03. lavabo appoggio CIRCLE cm 70x42 ECI 70. ECI 70 cm 70x42 over counter washbasin.
 04. lavabo appoggio CIRCLE cm 90x44 ECI 90. ECI 90 cm 90x44 over counter washbasin.



lavabo appoggio CIRCLE cm 40x40 **COLORS1250°** Cipria ECI 40 Cl, mensola MISURA .
 ECI 40 Cl cm 40x40 **COLORS1250°** Powder. over counter washbasin, MISURA shelf



lavabo appoggio CIRCLE cm 60x40 ECI 60, mensola MISURA.
ECI 60 cm 60x40 over counter washbasin, MISURA shelf



01.



02.

01. lavabo appoggio CIRCLE cm 60x40 **COLORS1250°** Edera ECI 60 ED, ECI 60 ED cm 60x40 over counter washbasin **COLORS1250°** Ivy.
02. lavabo appoggio monoforo CIRCLE cm 60x42 ECI 60M, ECI 60M cm 60x42 one hole over counter washbasin.



01.

02.

03.

01. lavabo appoggio monoforo CIRCLE cm 60x42 ECI 60M. ECI 60M cm 60x42 one hole over counter washbasin.
02. lavabo appoggio monoforo CIRCLE cm 70x42 ECI 70M. ECI 70M cm 70x42 one hole over counter washbasin.
03. lavabo appoggio monoforo CIRCLE cm 90x44 ECI 90M. ECI 90M cm 90x44 one hole over counter washbasin.



lavabo appoggio monoforo CIRCLE cm 70x42 **COLORS1250°** Cenere ECI 70 CE M, mensola MISURA.
ECI 70M cm 70x42 one hole over counter washbasin **COLORS1250°** Ash, MISURA mensola.



01. lavabo incasso/appoggio SOFT cm 45x40 ESO 45. ESO 45 cm 45x40 inset/over-counter washbasin.
 02. lavabo incasso/appoggio SOFT cm 60x40 ESO 60. ESO 60 cm 60x40 inset/over-counter washbasin.
 03. lavabo incasso/appoggio SOFT cm 75x40 ESO 75. ESO 75 cm 75x40 inset/over-counter washbasin.
 04. lavabo incasso/appoggio SOFT cm 90x40 ESO 90. ESO 90 cm 90x40 inset/over-counter washbasin.



lavabo incasso/appoggio SOFT cm 45x40 ESO 45, mensola MISURA.
 ESO 45 cm 45x40 inset/over-counter washbasin, MISURA shelf.



01.



02.

01. lavabo incasso/appoggio SOFT cm 60x40 **COLORS1250°** Rame ESO 60 RA, mensola MISURA.
ESO 60 RA cm 60x40 inset/over-counter washbasin **COLORS1250°** Copper, MISURA shelf

02. lavabo incasso/appoggio SOFT cm 75x40 ESO 75, mensola MISURA.
ESO 75 cm 75x40 inset/over-counter washbasin, MISURA shelf.



lavabo incasso/appoggio SOFT cm 90x40 ESO 90, mensola MISURA.
ESO 90 cm 90x40 inset/over-counter washbasin, MISURA shelf



01.

02.

03.



01. lavabo appoggio/sospeso SQUARED cm 50x45 EQA 50. EQA 50 cm 50x45 over-counter/wall-hung washbasin.
 02. lavabo appoggio/ sospeso SQUARED cm 60x45 EQA 60. EQA 60 cm 60x45 over-counter/ wall-hung washbasin.
 03. lavabo appoggio/ sospeso SQUARED cm 75x45 EQA 75. EQA 75 cm 75x45 over-counter/ wall-hung washbasin.

lavabo appoggio SQUARED cm 50x45 EQA 50. Rubinetteria LINEA cromo, mensola MISURA.
 EQA 50 cm 50x45 over-counter washbasin. LINEA chrome taps, MISURA shelf.



lavabo appoggio monoforo SQUARED cm 60x45 EQA 60M, mensola MISURA.
EQA 60M cm 60x45 one hole over-counter washbasin, MISURA shelf.



01.



02.

01. lavabo sospeso SQUARED cm 75x45 **bianco lucido** EQA 75, con portasciugami cromato.
EQA 75 cm 75x45 shiny white over-counter washbasin, with chromed towel-holder.
02. lavabo appoggio SQUARED cm 75x45 **bianco lucido** EQA 75, mensola MISURA.
EQA 75 cm 75x45 shiny white over-counter washbasin, MISURA shelf.



lavabo sospeso monoforo SQUARED cm 102x45 EQA 102M, con portasciugamani cromato.
EQA 102M cm 102x45 one hole wall hung washbasin, with chromed towel-holder.



01.



01. lavabo appoggio monoforo SQUARED cm 102x45 EQA 102M e mensola MISURA.
EQA 102M cm 102x45 one hole over-counter washbasin and MISURA shelf.



lavabo sospeso monoforo SQUARED cm 122x45 EQA 122 2V/2F, con 2 portasciugamani cromato.
EQA 122 2V/2F cm 102x45 one hole wall hung washbasin, with 2 chromed towel-holders.



01.



01. lavabo appoggio monoforo SQUARED cm 122x45 EQA 122 2V/2F, con 2 portasciugamani e mensola MISURA.
EQA 122 2V/SF cm 102x45 one hole over-counter washbasin, with 2 towel-holders and MISURA shelf.

CONSOLLE SIZE

design: OFFICINA AZZURRA

photographer: Studio 21

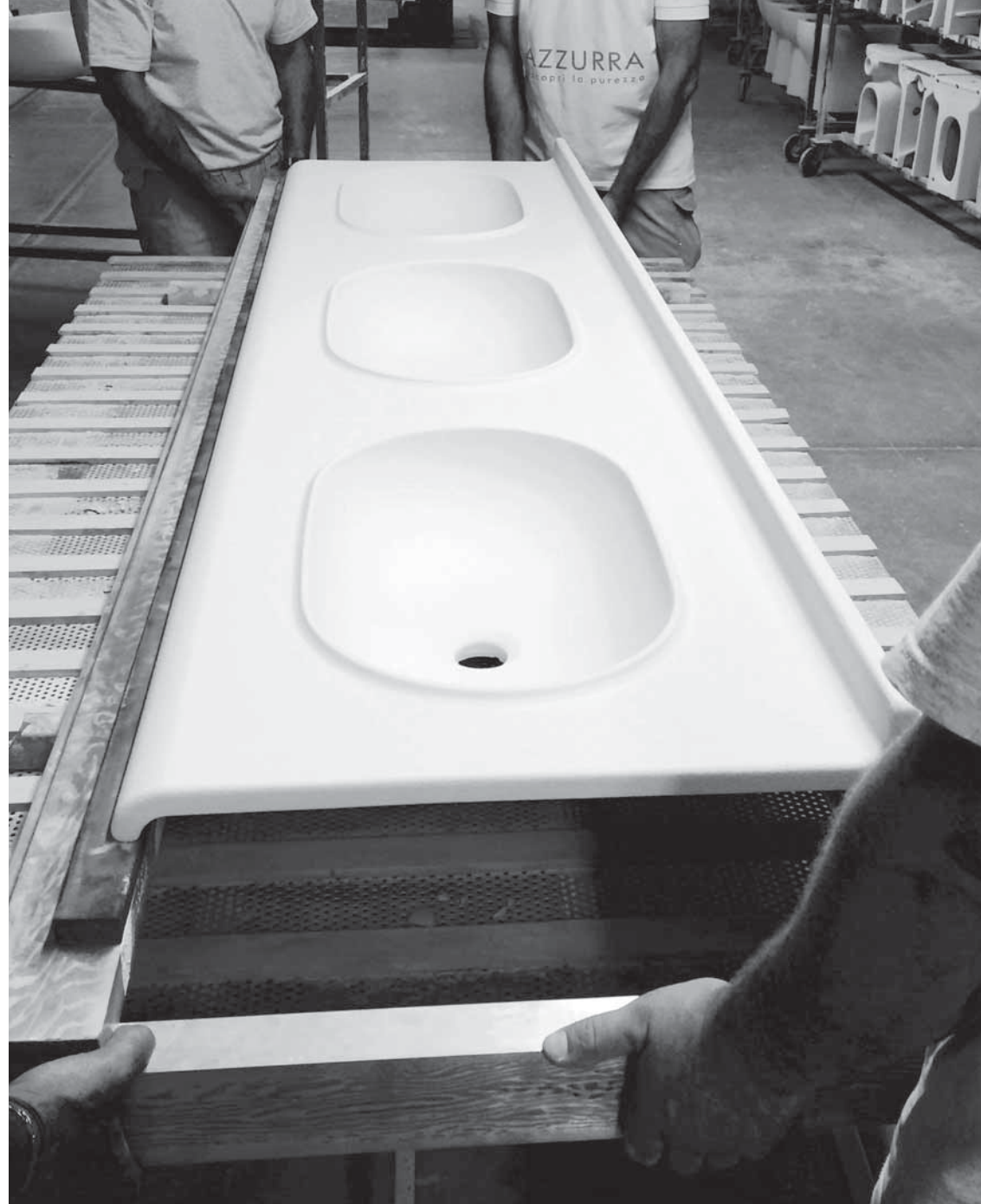



Trattamento **antibatterico** - **antifungo** applicabile su tutti i prodotti in ceramica e coprivasi.
 The **antibacterial** - **antifungal** treatment can be applied to all ceramic products and cover-seats.



coltone-cotton

bianco lucido-glossy white

Size è il nuovo piano in ceramica con lavabo integrato, un corpo unico, di soli 2 cm di spessore, che unisce piano e vasca. Azzurra mostra la sua grande capacità progettuale e produttiva offrendo al mercato un prodotto unico, realizzabile su misura sia nelle varianti dimensionali che nelle finiture. Size è disponibile con taglio al centimetro, realizzati manualmente, da 60 cm a 200 cm, con la possibilità di ospitare da 1 a 3 vasche. Il piano può essere realizzato anche con **taglio diagonale**: un nuovo brevetto firmato Azzurra. Finiture: bianco lucido, cotone.

Size is the new ceramic monolith with integrated sink, one unique piece, only 2 cm thickness, to combine a flat surface with the sink. Azzurra shows, its great ability to design and produce, offering the market a unique piece, customizable in sizes and finishing. Size can be cut on the centimeter, hand realized, from 60cm to 200cm, with the possibility to include 1, 2 or 3 sinks. The flat surface can be also realized with **diagonal cut**: a new patent signed by Azzurra. Finishing: glossy white, cotton.

CONSOLLE SIZE CON TAGLIO SU MISURA AL CM

Consolle Size custom made with cut to the centimeter

Disponibile soltanto 1 vasca

Only available with 1 sink



Consolle SIZE con possibilità di taglio al cm dimensione minima cm 60 dimensione massima cm 200

SIZE console with tailored diagonal cut to the centimeter minimum size cm 60 maximum size cm 200

Per il prezzo della consolle SIZE su misura verrà applicata una maggiorazione del 20 % rapportata alla misura standard superiore più vicina.

About price for SIZE custom made console a 20% increase will be applied on the base of the closest standard bigger size.

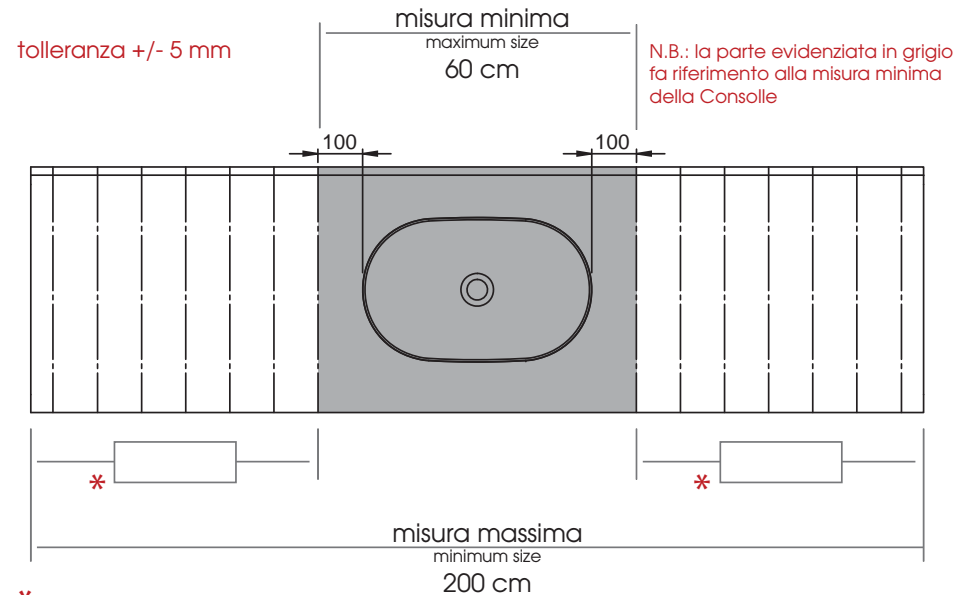

* indicare negli appositi spazi la misura definitiva e segnalare sullo schema le linee di taglio. Indicate the final size required inside the space and draw the cutting lines in the outline.

N.B.: prima di inoltrare l'ordine chiedere sempre conferma di fattibilità all'ufficio tecnico. Note: before sending the order always ask for confirmation and feasibility to the technical dept.

timbro e firma del cliente

CONSOLE SIZE CON TAGLIO IN DIAGONALE SU MISURA AL CM

Console Size custom made with diagonal cut to the centimeter

Disponibile soltanto 1 vasca

Only available with 1 sink



Console SIZE con possibilità di taglio al cm in diagonale dimensione minima cm 60 dimensione massima cm 200.
SIZE Console with tailored diagonal cut to the centimeter minimum size cm 60 maximum size cm 200.

Per il prezzo della consolle SIZE su misura verrà applicata una maggiorazione del 20 % rapportata alla misura standard superiore più vicina.
About Price for SIZE custom made console a 20% increase will be applied on the base of the closest standard bigger size.

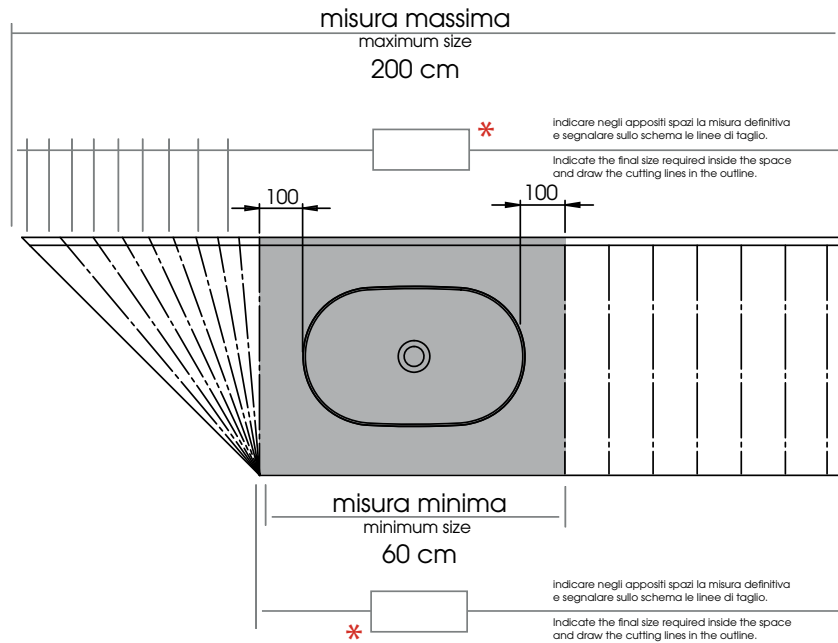

* indicare negli appositi spazi la misura definitiva e segnalare sullo schema le linee di taglio.
Indicate the final size required inside the space and draw the cutting lines in the outline.

N.B.: prima di inoltrare l'ordine chiedere sempre conferma di fattibilità all'ufficio tecnico.
Note: before sending the order always ask for confirmation and feasibility to the technical dept.

timbro e firma del cliente

CONSOLE SIZE CON TAGLIO IN DIAGONALE SU MISURA AL CM

Console Size custom made with diagonal cut to the centimeter

Disponibile soltanto 1 vasca

Only available with 1 sink



Console SIZE con possibilità di taglio al cm in diagonale dimensione minima cm 60 dimensione massima cm 200.
SIZE Console with tailored diagonal cut to the centimeter minimum size cm 60 maximum size cm 200.

Per il prezzo della consolle SIZE su misura verrà applicata una maggiorazione del 20 % rapportata alla misura standard superiore più vicina.
About Price for SIZE custom made console a 20% increase will be applied on the base of the closest standard bigger size.

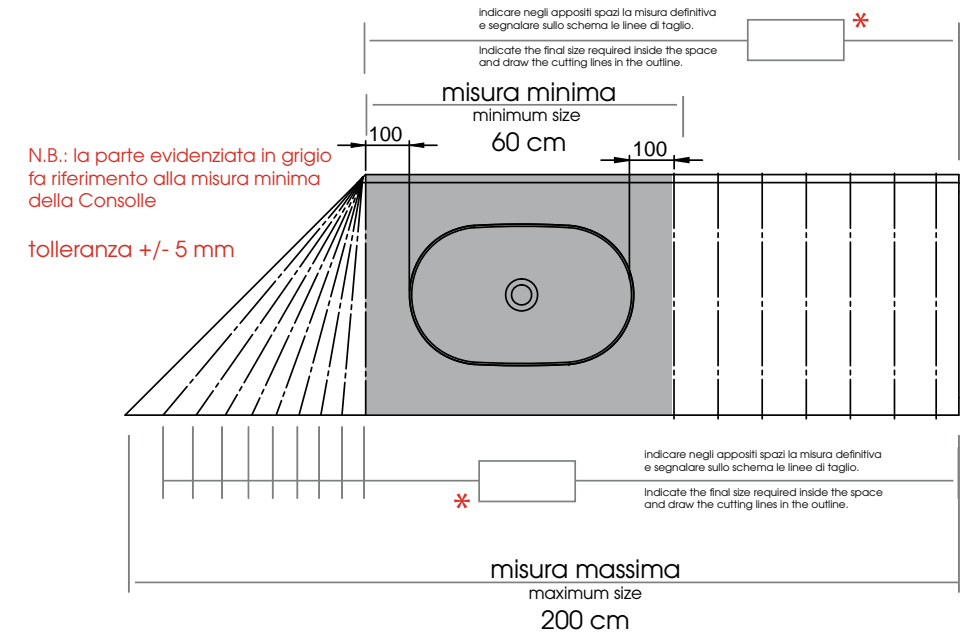

* indicare negli appositi spazi la misura definitiva e segnalare sullo schema le linee di taglio.
Indicate the final size required inside the space and draw the cutting lines in the outline.

N.B.: prima di inoltrare l'ordine chiedere sempre conferma di fattibilità all'ufficio tecnico.
Note: before sending the order always ask for confirmation and feasibility to the technical dept.

timbro e firma del cliente

CONSOLLE SLIM
design: OFFICINA AZZURRA



61X51XH18



SL 061

71X51XH18



SL 071

91X51XH18



SL 091

106X51XH18



SL 106

121X51XH18



SL 121

121X51XH18



SL 121 2V



lavabo sospeso SLIM SL071 cm 71
SLIM SL071 cm 71 wall-hung washbasin



Trattamento **antibatterico** - **antifungo** applicabile su tutti i prodotti in ceramica e coprivasi.
The treatment antibacterial - antifungal can be applied to all ceramic products and seat-cover.



consolle appoggio monoforo SLIM cm 71x51 SL 071. Mobile con due cassettoni finitura Noce.
SL 071 cm 71x51 one hole over-counter consolle. Walnut finishing furniture with 2 big drawers.



consolle appoggio monoforo SLIM cm 61x51 SL 061. Mobile con due cassettoni finitura laccato bianco lucido. SL 071 cm 71x51 one hole over-counter consolle. Lacquered shiny white finishing furniture with 2 drawers.



consolle sospesa doppia vasca cm 121x51 SL 121 2V
SL 121 2V cm 121x51 wall-hung consolle with double sink



consolle appoggio monoforo SLIM cm 91x51 SL 091. Mobile con due cassettoni finitura frassino.
SL 091 cm 91x51 one hole over-counter consolle. Frassino finishing furniture with 2 big drawers.



consolle sospeso doppia vasca cm 121x51 SL 121 2V. Mobile con due cassettoni finitura noce, specchio cm 115x68.
SL 121 2V cm 121x51 wall-hung consolle with double sink. Walnut finishing furniture with 2 drawers, mirror 115x68 cm.

LAVABI ARREDO
washbasin

photographer: Paolo Veclani
interiors e styling: Michele Pasini, Storage
photographer: Studio 21





Trattamento **antibatterico - antifungo** applicabile su tutti i prodotti in ceramica e coprivasi.
The treatment antibacterial - antifungal can be applied to all ceramic products and seat-cover.





01.lavabo appoggio CLIP cm 45 CLI 45 / CLI 45 cm. 45 over-counter washbasin
02.lavabo appoggio CLIP cm 60 CLI 60 / CLI 60 cm. 60 over-counter washbasin



la collezione CLIP è disponibile anche nella finitura CORTECCIA.
CLIP collection is also available with CORTECCIA finishing.

CORTECCIA

BIANCO WHITE	NERO BLACK	GRIGIO GREY
-----------------	---------------	----------------



CORTECCIA finitura brevettata / patented finishing



BIANCO CORTECCIA / WHITE CORTECCIA

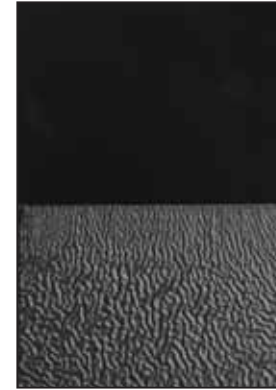

NERO CORTECCIA / BLACK CORTECCIA



GRIGIO CORTECCIA / GREY CORTECCIA

Finiture disponibili sulle serie
NATIVO/CLIP 45-60x45
Finishing available on
NATIVO/CLIP 45-60x45

L'aspetto non uniforme della finitura CORTECCIA è una caratteristica voluta del prodotto, che rende questa **finitura unica** ed ogni pezzo non replicabile in serie.
CORTECCIA patchy effect finishing is one of the intentionally distinguishing feature of this piece which makes each pieces unique and not liable for scale reproduction.



01.



02.



01.lavabo appoggio 45 x45 VER 45/APP
cm 45x45 VER 45/APP over-counter washbasin
02.lavabo appoggio 75x45 VER 75/APP
cm 75x45 VER 75/APP over-counter washbasin

lavabi appoggio VERA VER 45 APP/VER 75 APP. Mensola laccata bianca ME 170 B. Specchi NEWS PAPER THS 58 D, rubinetteria LINEA.
VER 45 APP/VER 75 APP VERA washbasin. ME 170 B lacquered polish white shelf. NEWS PAPER THS 58 D mirrors. LINEA mixer.



lavabo appoggio Round ø30 ROU30, rubinetteria LINEA
cm ø30 ROU30 Round over-counter washbasin, LINEA taps



lavabo appoggio Oval 49x30 OV49, rubinetteria LINEA, mensola MISURA.
cm 49x30 OV49 Oval over-counter washbasin, LINEA taps, MISURA mensola.



01.

02.

03.

01.lavabo ø40,5 da appoggio GRA AP4 in terracotta naturale o smaltato in 8 varianti di colore. Riferimento tabella colori, nelle schede tecniche GRA AP4 ø40,5 over-counter washbasin made of natural earthenware or enamelled in 8 different colours. The colour list is available in the technical area.

02.lavabo 60 da appoggio NUV 200/AP6 / NUV 200/AP6 60 over-counter washbasin

03.lavabo 75 da appoggio NUV 200/AP8 / NUV 200/AP8 75 over-counter washbasin



lavabo 75 in appoggio NUV 200/AP8
NUV 200/AP8 75 over-counter washbasin



lavabo appoggio JUB50/APP/ JUB50/APP over-counter washbasin



lavabo appoggio JUB45/APP/ JUB45/APP over-counter washbasin



01.



02.



01.lavabo appoggio cm ø45 cod. FLE 200 CA COLORS 1250° carbone
FLE 200 CA ø 45cm over-counter washbasin COLORS 1250° caol
02.lavabo appoggio cm ø45 cod. FLE 200 TO COLORS 1250° tortora
FLE 200 TO ø 45cm over-counter washbasin COLORS 1250° taupe

lavabo appoggio cm ø45 cod. FLE 200, rubinetteria LINEA / FLE 200 ø 45cm over-counter washbasin, LINEA taps



lavabo incasso cm 60x40 THI 60/IN. THI 60/IN cm 60x40 Inset washbasin



01.



02.



03.

01.lavabo appoggio cm 60 GLZ 260/APP. GLZ 260/APP cm 60 over-counter washbasin
02.lavabo incasso cm 50 GLZ 50x40/IN GLZ 50x40/IN cm 50 inset washbasin
03.lavabo incasso cm 70 GLZ 69x38/IN GLZ 69x38/IN cm 70 inset washbasin



lavabo sottopiano cm 69 GLZ 69x38/SP. Mobile sospeso con anta a ribalta unica in walnut. Specchio MIRROR BOOK. Rubinetteria LINEA GLZ 69x38/SP cm 69 inset washbasin. Wall hung furniture with single drop-leaf drawer, finishing walnut. Mirror MIRROR BOOK. LINEA taps



lavabo appoggio cm 60 GLZ 260/APP su mobile in walnut, specchio MIRROR BOOK
GLZ 260/APP cm 60 over-counter washbasin on furniture walnut finishing, MIRROR BOOK mirror



lavabo appoggio cm 55 OVA 55/APP / OVA 55/APP over-counter washbasin



lavabo appoggio cm 25x25 Geometrico GEO25. Rubinetteria LINEA, mensola MISURA.
cm 25x25 GEO25 Geometric over-counter washbasin. LINEA taps, MISURA shelf.



01.



02.

01.lavabo appoggio monoforo cm 41x25 GEO41M, rubinetteria LINEA, mensola MISURA.
GEO41M cm 41x25 one hole over-counter washbasin, LINEA taps, MISURA shelf
02.lavabo appoggio cm 41x25 GEO41, rubinetteria LINEA, mensola MISURA.
GEO41 cm 41x25 over-counter washbasin, LINEA taps, MISURA shelf.

MENSOLA MISURA
MISURA shelf

design: OFFICINA AZZURRA

photographer: Studio 21





Azzurra cavalca le tendenze più attuali del mondo del bagno, offrendo soluzioni uniche, innovative e funzionali. Misura è la nuova mensola che, con uno spessore di soli 2 cm, viene realizzata su misura con taglio al centimetro e proposta in varianti dimensionali pressoché infinite (da 60 cm a 2 metri con taglio al centimetro). Inoltre può essere eseguito anche il taglio in profondità da 55 cm a 45 cm. Misura è stata pensata in abbinamento ai lavabi Elegance e, oltre al bianco lucido, è disponibile nella gamma cromatica Colors 1250° per offrire un totale allineamento cromatico tra lavabo e supporto o un originale contrasto.

Azzurra has always aimed to reach new goals about the ceramic designing and processing, riding trends, offering innovative and functional solutions. MISURA is the new shelf, only 2 cm thick, realized on request, cut to the centimeter and available in many different sizes almost endless (from 60 cm to 2 meters with customized cut). Also it can be run the cutting depth from 55 to 45 cm. Misura was designed in combination with Elegance Washbasins and the color range "Colors 1250°" is available, in addition to the glossy white, to create a perfect chromatic alignment or an original contrast between basin and shelf.

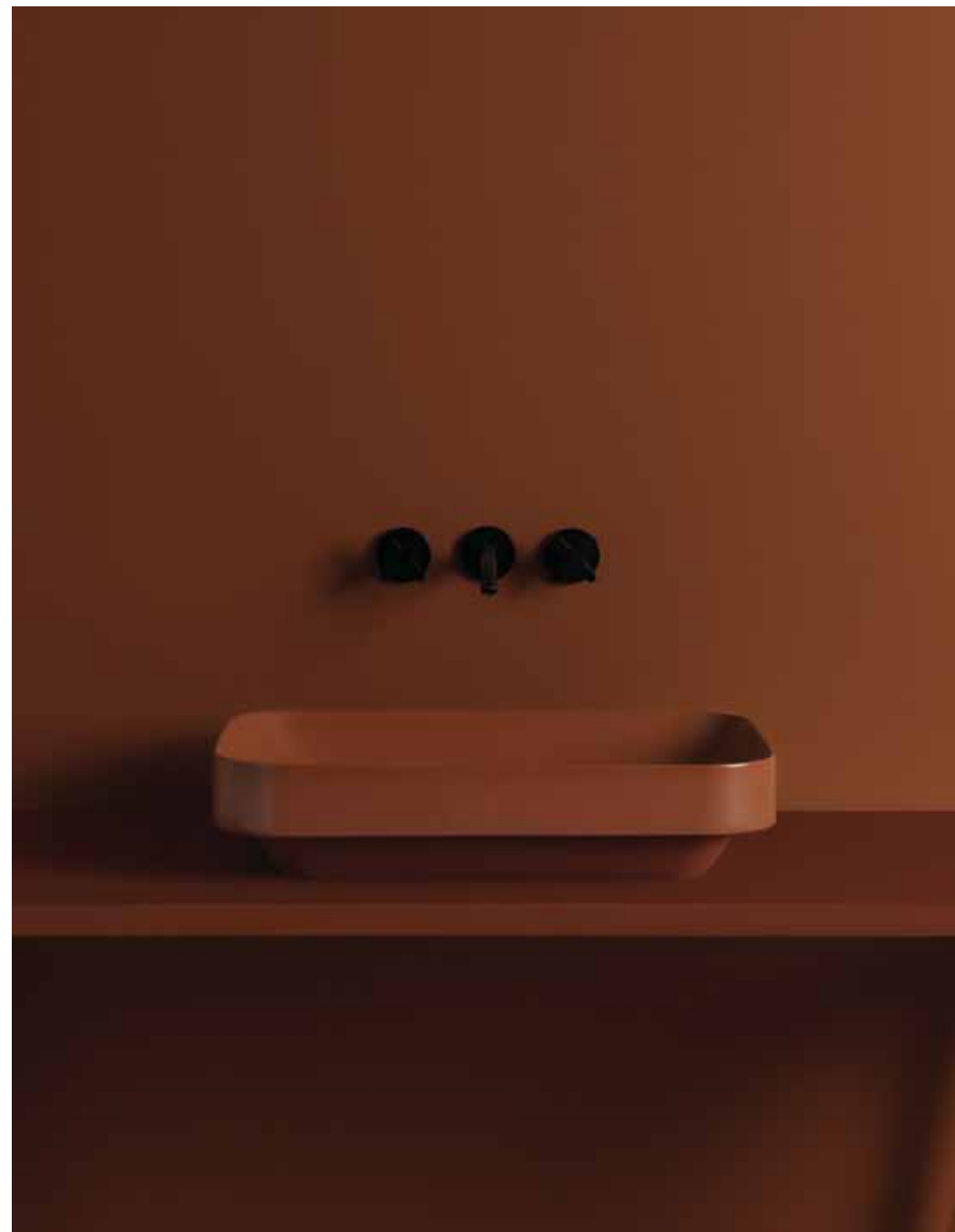

COLORS 1250°

COTONE COTTON	CARBONE COAL	CENERE ASH	PERLA PEARL	CIPRIA POWDER	TORTORA TAUPE	RAME COPPER	SALVIA SAGE	EDERA IVY
CO	CA	CE	PE	CI	TO	RA	SA	ED

MENSOLA MISURA CON TAGLIO AL CM

COLORS 1250°



Mensola MISURA con possibilità di taglio al cm dimensione minima cm 60 dimensione massima cm 200

MISURA shelf with tailored cut to the centimeter minimum size cm 60 maximum size cm 200



Per il prezzo della mensola su misura verrà applicata una maggiorazione del 20 % rapportata alla misura standard superiore più vicina.

About price for shelf custom made console a 20% increase will be applied on the base of the closest standard bigger size.

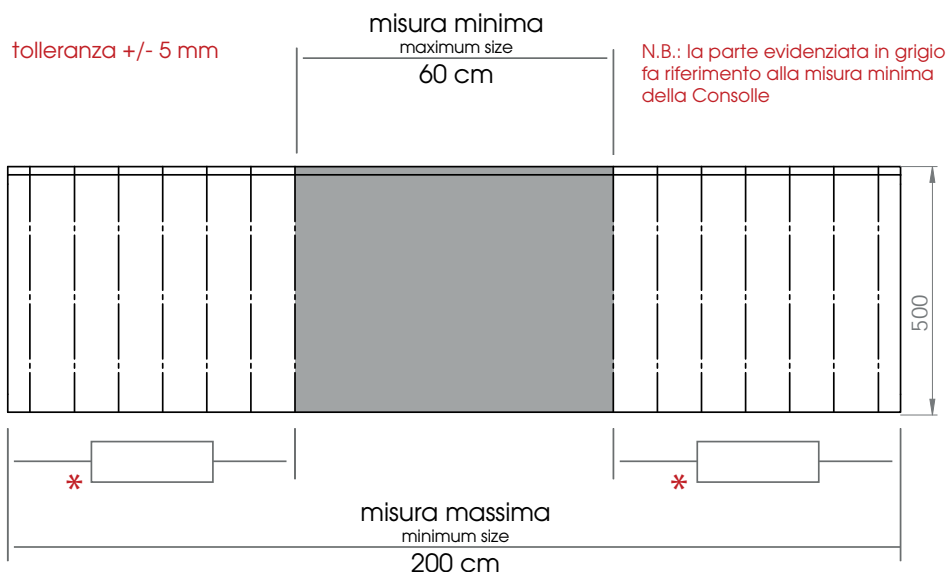

*

indicare negli appositi spazi la misura definitiva e segnalare sullo schema le linee di taglio.
Indicate the final size required inside the space and draw the cutting lines in the outline.

N.B.: prima di inoltrare l'ordine chiedere sempre conferma di fattibilità all'ufficio tecnico.
Note: before sending the order always ask for confirmation and feasibility to the technical dept.

timbro e firma del cliente

MENSOLA MISURA CON TAGLIO IN DIAGONALE AL CM

COLORS 1250°



Mensola MISURA con possibilità di taglio al cm dimensione minima cm 60 dimensione massima cm 200

MISURA shelf with tailored diagonal cut to the centimeter minimum size cm 60 maximum size cm 200



Per il prezzo della mensola su misura verrà applicata una maggiorazione del 20 % rapportata alla misura standard superiore più vicina.

About price for shelf custom made console a 20% increase will be applied on the base of the closest standard bigger size.

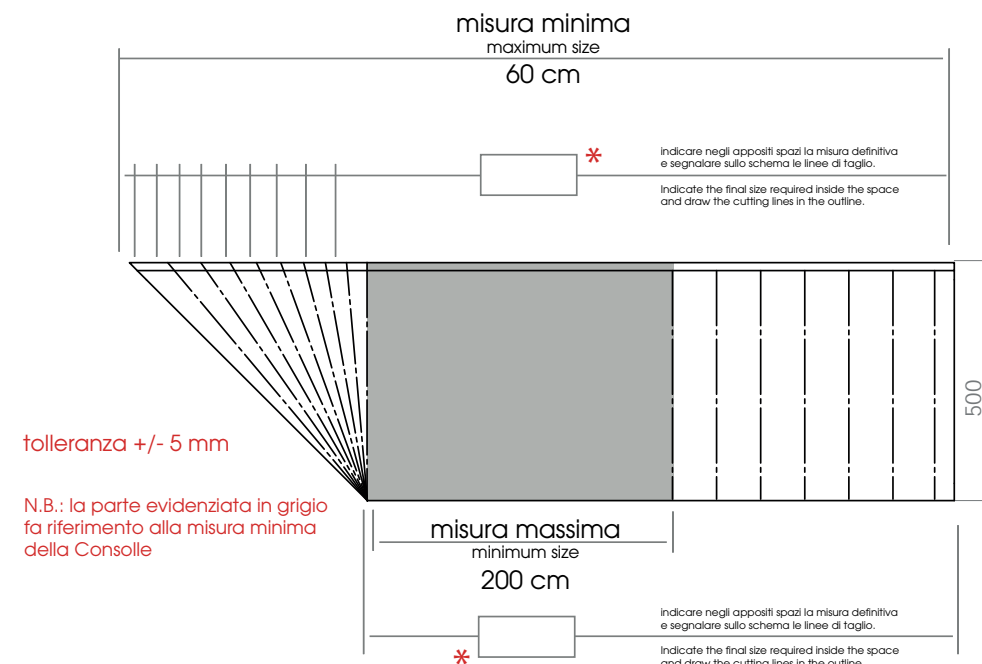

*

indicare negli appositi spazi la misura definitiva e segnalare sullo schema le linee di taglio.
Indicate the final size required inside the space and draw the cutting lines in the outline.

N.B.: prima di inoltrare l'ordine chiedere sempre conferma di fattibilità all'ufficio tecnico.
Note: before sending the order always ask for confirmation and feasibility to the technical dept.

timbro e firma del cliente

MENSOLA MISURA CON TAGLIO IN DIAGONALE AL CM

COLORS 1250°



Mensola MISURA con possibilità di taglio al cm in diagonale dimensione minima cm 60 dimensione massima cm 200.

MISURA shelf with tailored diagonal cut to the centimeter minimum size cm 60 maximum size cm 200.

Per il prezzo della mensola su misura verrà applicata una maggiorazione del 20 % rapportata alla misura standard superiore più vicina.

About price for shelf custom made console a 20% increase will be applied on the base of the closest standard bigger size.



N.B.: la parte evidenziata in grigio fa riferimento alla misura minima della Consolle

tolleranza +/- 5 mm

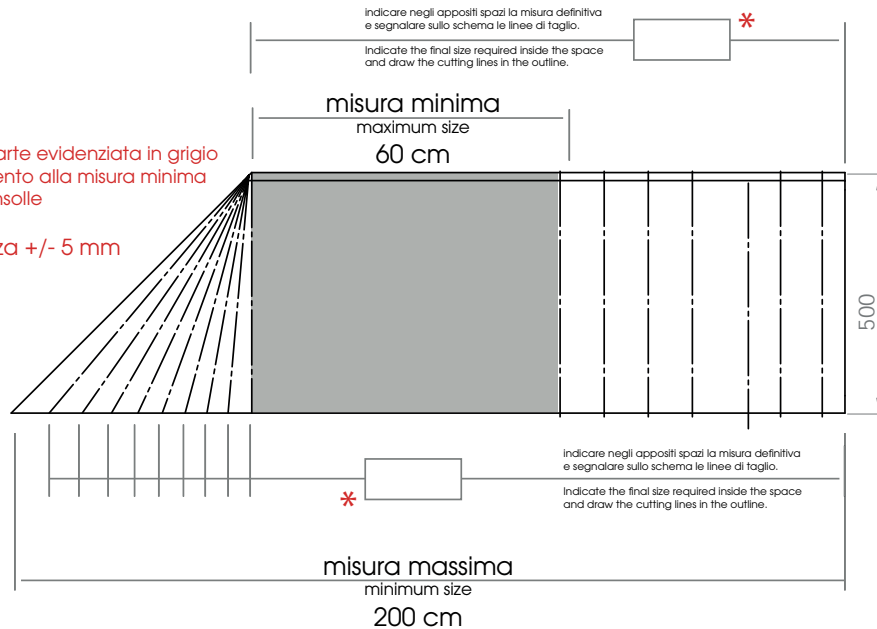

*

Indicare negli appositi spazi la misura definitiva e segnalare sullo schema le linee di taglio.
Indicate the final size required inside the space and draw the cutting lines in the outline.

N.B.: prima di inoltrare l'ordine chiedere sempre conferma di fattibilità all'ufficio tecnico.
Note: before sending the order always ask for confirmation and feasibility to the technical dept.

timbro e firma del cliente

LAVABI DA ABBINARE alla MENSOLA MISURA

WASHBASIN TO THE COMBINE WITH MISURA SHELF

LAVABI ELEGANCE ELEGANCE WASHBASIN

ECI 40
ECI 60
ECI 70
ECI 90

ECI60M
ECI70M
ECI90M

EQA50
EQA60
EQA75

EQA50M
EQA60M
EQA75M

LAVABI CLIP APPOGGIO CLIP WASHBASIN COUNTER TOP

CLI45
CLI60

LAVABI NUVOLA APPOGGIO NUVOLA WASHBASIN COUNTER TOP

NUV200/AP6
NUV200/AP8

LAVABI GLAZE APPOGGIO GLAZE WASHBASIN COUNTER TOP

GLZ260/APP

LAVABI JUBILAEUM APPOGGIO JUBILAEUM WASHBASIN COUNTER TOP

JUB45/APP

LAVABI FLEUR APPOGGIO FLEUR WASHBASIN COUNTER TOP

FLE200

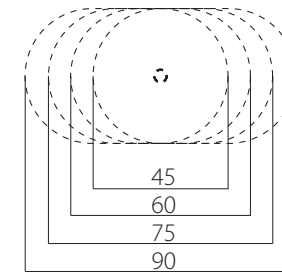

ATTENZIONE: al momento dell'ordine specificare il codice del lavabo

ATTENTION: specify washbasin code when ordering

Hang&Stand

design: StorageAssociati

photographer: Studio 21

Il sistema modulare **Hang&Stand** interpreta il concetto di funzionalità, modularità ed estetica dei prodotti Azzurra. Un progetto che fa della versatilità la propria qualità principale, lavorando sul concetto di **struttura componibile che offre un supporto di grande personalità per la mensola Misura**. Disponibile nella versione sospesa o a terra, Hang&Stand crea una cornice che funge anche da piano d'appoggio per lavabo e accessori ogni volta diversi e personalizzabili. Ripiani, cassettiere, barra porta asciugamani con modularità orizzontale e di ispirazione industriale, declinabili in infinite soluzioni progettuali.

Hang&Stand perfectly interprets the concept of functionality, modularity and aesthetic typical of Azzurra's products. Versatility is proper of this project, working on the concept of **modular structure to offer an high personality to the Misura shelf**. It's available in wall hung and floor mounted version, Hang&Stand also has a supportive function for the basin and the accessories always different and customizable. Shelves, drawers, towel bar with horizontal modularity and industrial inspiration, expressed in an endless variety of solutions.



Hang& stand realizzato in metallo verniciato bianco opaco o antracite con due cassettoni e piano porta oggetti in legno rovere tabu o bianco opaco. La mensola Misura, è disponibile nelle cromie del progetto Colors1250° per un bagno total color o per un inedito mix&match.

HANG & STAND is realized in satinized matt white or charcoal metal with two drawers and oak wood storage in matt white or tabu color. Misura shelf, is available with the tonalities of "Colors1250°" for a full colored bathroom and an original mix&match.

Hang



Stand



Stand



lavabo appoggio CIRCLE cm ø40 ECI 40, struttura a terra STAND in metallo verniciato con 2 mensole a misura cm 67 con foro centrale, piano in legno porta oggetti e mobile con 2 cassetti e portasciugamani integrato. Rubinetteria LINEA.
 ECI 40 cm ø40 over-counter washbasin, floors standing painted metal stand structure provided 2 ceramic custom made shelves 67cm with central hole, wood top and furniture with 2 drawers. LINEA taps



Struttura sospesa **HANG** in metallo verniciato bianca completa di mensola a misura cm 120 e piano in legno con portasciugamani integrato. Rubinetteria LINEA.
 White wall hung painted metal structure Hang provided with ceramic custom made shelf 120cm and wood top. LINEA taps



01.



02.

01. Struttura a terra **STAND** in metallo verniciato con mensola a misura cm 142 con foro centrale, piano in legno porta oggetti e mobile con 2 cassetti bianchi opachi e portasciugamani integrato. Rubinetteria LINEA. Floors standing painted metal stand structure provided ceramic custom made shelves 142cm with central hole, wood top and furniture with 2 drawers. LINEA taps
 02. Struttura sospesa **HANG** in metallo verniciato antracite completa di mensola a misura cm 120 carbone e piano in legno rovere con portasciugamani integrato. Rubinetteria LINEA.
 Anthracite wall hung painted metal structure Hang provided with ceramic custom made shelf 120cm ash and wood top. LINEA taps.

HANG 90 /120 /180 dimensioni piani "MISURA"
 HANG 90 /120 /180 dimensions top "MISURA"

piano MISURA: cm alt.2 X largh.90 X prof.49,5
 top MISURA: cm height 2 X width 90 X depth 49,5

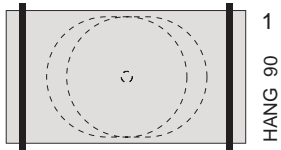

piano MISURA: cm alt.2 X largh.120 X prof.49,5
 top MISURA: cm height 2 X width 120 X depth 49,5

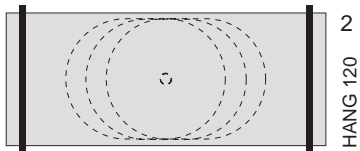

piano MISURA: cm alt.2 X largh.180 X prof.49,5
 top MISURA: cm height 2 X width 180 X depth 49,5

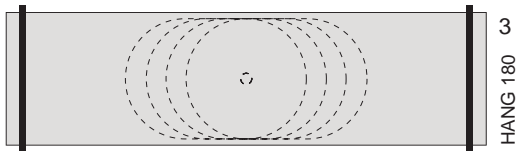

piano MISURA: cm alt.2 X largh.180 X prof.49,5
 top MISURA: cm height 2 X width 180 X depth 49,5

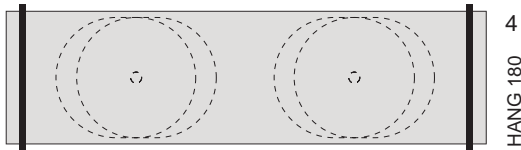

LAVABI DA ABBINARE a HANG e STAND
 WASHBASINS TO COMBINE WITH HANG AND STAND

LAVABI ELEGANCE
 ELEGANCE WASHBASIN

ECI 40
 ECI 60
 ECI70
 ECI90

ECI60M
 ECI70M
 ECI90M

EQA50
 EQA60
 EQA75

EQA50M
 EQA60M
 EQA75M

LAVABI CLIP APPOGGIO
 CLIP WASHBASIN COUNTER TOP

CLI45
 CLI60

LAVABI NUVOLA APPOGGIO
 NUVOLA WASHBASIN COUNTER TOP

NUV200/AP6
 NUV200/AP8

LAVABI GLAZE APPOGGIO
 GLAZE WASHBASIN COUNTER TOP

GLZ260/APP

LAVABI JUBILAEUM APPOGGIO
 JUBILAEUM WASHBASIN COUNTER TOP

JUB45/APP

LAVABI FLEUR APPOGGIO
 FLEUR WASHBASIN COUNTER TOP

FLE200

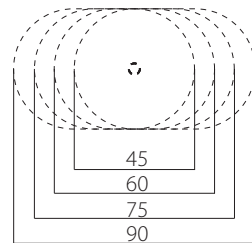

ATTENZIONE: al momento dell'ordine specificare il codice del lavabo
 ATTENTION: specify washbasin code when ordering

STAND 120 dimensioni PIANI "MISURA"
 STAND 120 "MISURA" top dimensions

piano MISURA: cm alt.2 X largh. 82 X prof.49,5
 top MISURA: cm height 2 X width 82 X depth 49,5

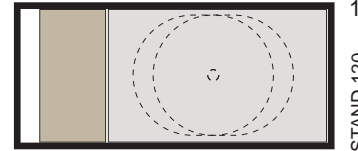

piano MISURA: cm alt.2 X largh.100 X prof.49,5
 top MISURA: cm height 2 X width 100 X depth 49,5

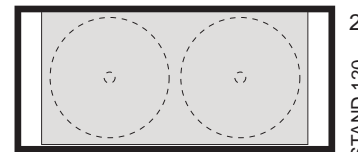

piano MISURA: cm alt.2 X largh.100 X prof.49,5
 top MISURA: cm height 2 X width 100 X depth 49,5

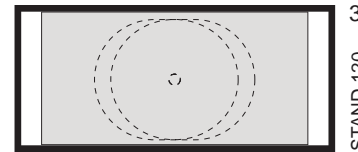

piano MISURA: cm alt.2 X largh.107 X prof.49,5
 top MISURA: cm height 2 X width 107 X depth 49,5

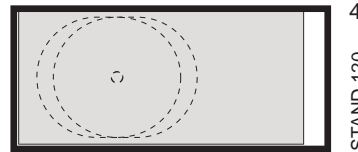

STAND 180 dimensioni PIANI "MISURA"
 STAND 180 "MISURA" top dimensions

piano MISURA: cm alt.2 X largh. 142 X prof.49,5
 top MISURA: cm height 2 X width 142 X depth 49,5

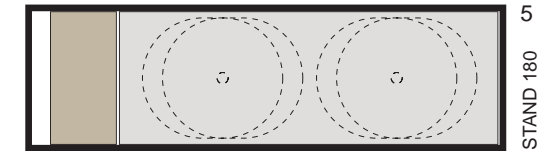

piano MISURA: cm alt.2 X largh. 142 X prof.49,5
 top MISURA: cm height 2 X width 142 X depth 49,5

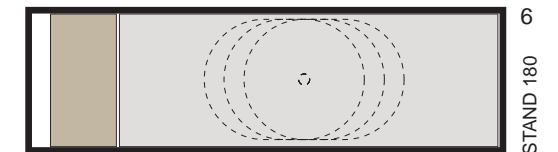

piano MISURA: cm alt.2 X largh. 67 X prof.49,5 / 2 pz
 top MISURA: cm height 2 X width 67 X depth 49,5 / pcs

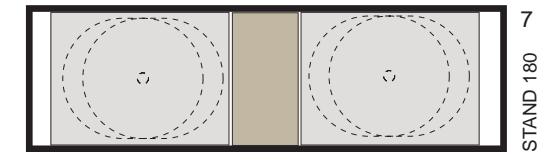

PIANO MISURA H20XL160XP495

piano MISURA: cm alt.2 X largh. 160 X prof.49,5
 top MISURA: cm height 2 X width 160 X depth

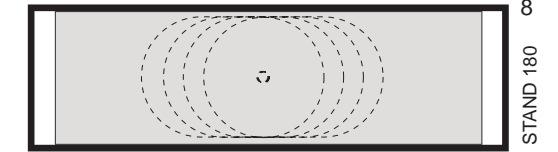

piano MISURA: cm alt.2 X largh. 160 X prof.49,5
 top MISURA: cm height 2 X width 160 X depth

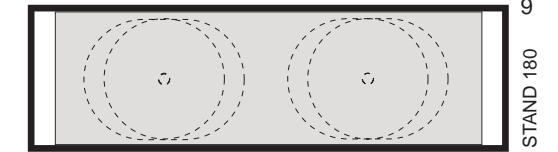

MOBILI
furniture

angeletti ruzza design

photographer: Paolo Veciani
photographer: Studio 21

MIRROR BOOK

design: Storage

photographer: Paolo Veciani
interiors e styling: Michele Pasini, Storage





PRUA lavabo sospeso cm 75x45 PRU 275. Mobile sospeso STIVA con 2 cassetti bianchi, specchio orizzontale PRUA. Rubinetteria LINEA PRU 275 cm 75x45 wall hung washbasin. STIVA wall hung furniture with 2 white drawers, PRUA horizontal mirror. LINEA taps.

vaso e bidet a terra cm 52x35 PRU 100 - PRU 500. Rubinetteria LINEA. PRU 100 - PRU 500 cm 52x35 floor mounted wc and bidet. LINEA taps.



lavabo appoggio/incasso cm 50x40 PRU 50/IN. Mobile STIVA con 2 cassetti bianchi, specchio orizzontale PRUA.
 PRU 50/IN cm 50x40 over counter/inset washbasin. STIVA furniture with 2 white drawers, PRUA horizontal mirror.



01.

01. lavabo sospeso cm 75 PRU 275. Portasciugamani PRUA; specchio verticale PRUA; mobile STIVA a terra con cassettone.
 PRU 275 cm 75 wall hung washbasin. PRUA towel holder; PRUA vertical mirror; STIVA floor furniture with big drawer.



02.

02. lavabo sospeso cm 75x45 PRU 275. Mobile sospeso STIVA con 2 cassetti bianchi.
 PRU 275 cm 75x45 wall hung washbasin. STIVA wall hung furniture with 2 white drawers.



mobili collezione TULIP con cassetto, lavabo TULIP, rubinetteria LINEA, specchio MIRROR BOOK.
furniture collection TULIP with drawer, washbasin TULIP, taps LINE BOOK MIRROR mirror.



01.



02.



03.



01. lavabo e mobile TULIP walnut cm 75 / cm 75 TULIP washbasin and furniture walnut.
02. lavabo e mobile TULIP walnut cm 90 / cm 90 TULIP washbasin and furniture walnut.
03. particolare mobile TULIP walnut / TULIP furniture detail walnut.



Mobile laccato con cassetto cm 110. Rubinetteria LINEA con cartuccia joystick e lavabo GLAZE appoggio cm 60, specchio NEWSPAPER.
Cm 110 furniture with drop-leaf. LINEA taps with joystick cartridge and GLAZE over-counter cm60 washbasin, NEWSPAPER mirror.



lavabo TANDEM e mobile sospeso con anta a ribalta cm 120. Rubinetteria LINEA TANDEM washbasin and cm 120 hang furniture with drop/leafdoor. LINEA taps



01.



02.

01. lavabo incasso GLAZE GLZ 69x38 IN monocomando LINEA/ GLZ 69x38 IN inset washbasin, LINEA single control.
02. lavabi appoggio GLAZE GLZ 260 APP su panca in betulla ME 200 CV / GLZ 260 APP GLAZE over counter washbasin on birch trestless.



specchio mirror book.
mirror book.



specchio mirror book doppio MB 58D basculante con interno portaoggetti in acciaio verniciato a polvere epossidica bianco opaco.
MB 58D double adjustable mirror book, with internal steel shelf-holders lacquered with matt white epoxy powder.

NATIVO

design: Giovanni Levanti

photographer: Paolo Veclani
interiors e styling: Michele Pasini, Storage



lavabo NATIVO, rubinetteria LINEA, specchio MIRROR BOOK.
NATIVO washbasin, LINEA taps and fitting, MIRROR BOOK.



NATIVO è disponibile anche nella finitura CORTECCIA.
 NATIVO is also available in CORTECCIA finishing.



Art. NAC 200/b bianco CORTECCIA
 Art. NAC 200/b CORTECCIA white



Art. NAC 200/n nero CORTECCIA
 Art. NAC 200/n CORTECCIA black



Art. NAC 200/g grigio CORTECCIA
 Art. NAC 200/g CORTECCIA grey



Art. NAT 200 bianco lucido
 Art. NAT 200 glossy white



Art. NAT 200/n nero lucido
 Art. NAT 200/n glossy black

Il lavabo NATIVO può essere installato soltanto sospeso
 Nativo washbasin can only be installed wall-hung.



lavabi NATIVO, wc bidet VERA, rubinetteria LINEA, specchi MIRROR BOOK.
NATIVO washbasins, VERA wc bidet, LINEA taps and fitting, MIRROR BOOK mirrors.

FLEUR

design: Laudani & Romanelli
con Filippo Francescangeli

photographer: Sebastiano Luciani
photographer: Studio 21





lavabo appoggio FLEUR colors 1250 perla FLE 200 PE/IN, rubinetteria LINEA FLE 200 PE/IN FLEUR colors 1250 pearl over-counter washbasin, LINEA taps



lavabo appoggio FLEUR cotone FLE 200CO, rubinetteria LINEA FLE 200CO FLEUR cotton over-counter washbasin, LINEA taps



01.

COLORS 1250°

COTONE COTTON CO	CARBONE COAL CA	CENERE ASH CE	PERLA PEARL PE	CIPRIA POWDER CI	TORTORA TAUPE TO	RAME COPPER RA	SALVIA SAGE SA	EDERA IVY ED
------------------------	-----------------------	---------------------	----------------------	------------------------	------------------------	----------------------	----------------------	--------------------



02.



03.

01. lavabo appoggio FLEUR bianco lucido FLE 200, rubinetteria LINEA/FLE 200 FLEUR shiny white over-counter washbasin, LINEA taps
 02. lavabo appoggio FLEUR carbone FLE 200 CA / FLE 200 CA FLEUR coal over-counter washbasin
 03. lavabo appoggio FLEUR edera FLE 200 ED, rubinetteria LINEA / FLE 200 ED FLEUR ivy over-counter washbasin, LINEA taps



01.

LAVABI FLEUR ORO / FLEUR GOLD WASHBASIN



Art. FLE 200OR/N oro-nero
Art. FLE 200OR/N gold-black



Art. FLE 200OR/R oro-rosso
Art. FLE 200OR/R gold-red



Art. FLE 200OR/V oro-verde
Art. FLE 200OR/V gold-green



Art. FLE 200OR/BB oro-blu
Art. FLE 200OR/BB gold-blue



Art. FLE 200OR/A oro-arancio
Art. FLE 200OR/A gold-orange



Art. FLE 200OR oro
Art. FLE 200OR gold



02.

LAVABI FLEUR PLATINO / FLEUR PLATINUM WASHBASIN



Art. FLE 200PL/N platino-nero
Art. FLE 200PL/N platinum-black



Art. FLE 200PL/BB platino-blu
Art. FLE 200PL/BB platinum-blue



Art. FLE 200PL/B platino-bianco
Art. FLE 200PL/B platinum-white



Art. FLE 200PL platino
Art. FLE 200PL platinum

01. lavabi appoggio FLEUR oro-verde FLE 200OR/V, rubinetteria LINEA oro FLE 200OR/V FLEUR gold-green over-counter washbasins, LINEA gold taps
02. lavabo appoggio FLEUR platino-bianco FLE 200PL/B, rubinetteria LINEA FLE 200PL/B FLEUR platinum-white over-counter washbasin, LINEA taps

POOL

design: Martí Guixé

photographer: Paolo Veclani
interiors e styling: Michele Pasini, Storage

AZZURRA riceve il DESIGN PLUS, uno dei massimi riconoscimenti in tema di design, ricerca, innovazione e sostenibilità ambientale, per il lavabo POOL

AZZURRA has received for the washbasin POOL the DESIGN PLUS, one of the greatest award concerning design, innovation and respect for the environment

DESIGN PLUS 2011





lavabo Pool 80x32 in acciaio inox verniciato a polveri epossidiche bianco opaco POO 200 , accessori in teak POORI/POOMO, monocomando ad incasso Linea. Vaso e bidet sospesi Thin THI156/sosk - THI 556/sosk, monocomando per bidet Linea AN 45.
POO 200 80x32 Pool inox steel washbasin lacquered with matt white epoxy powder, POORI/POOMO teak accessories, Linea inset single control mixer, THI156/sosk - THI 556/sosk Thin wall-hung WC and bidet, AN 45 Linea bidet single control mixer.



Mollella portasciugamani POOMO, piano portasapone e il piano interno in teak POOR! sono gli accessori che completano il lavabo POOL. POOMO towel-holder peg, soap-holder top and internal teak top are the accessories that complement POOL washbasin.

GRAAL

angeletti ruzza design

photographer: Paolo Veclani
interiors e styling: Michele Pasini, Storage





lavabo GRAAL in terracotta smaltata grigio caldo, rubinetteria LINEA. Piatto doccia uniKo.

GRAAL warm grey washbasin made of enamelled earthen, LINEA taps. UniKo shower tray.



01.

01. particolare della lavorazione di smaltatura per il lavabo appoggio GRAAL
detail of the enamelling process of the GRAAL over-counter washbasin



Art. GRA 001 naturale
Art. GRA 001 natural



Art. GRA 002 grigio caldo
Art. GRA 002 warm grey



Art. GRA 003 grigio minerale
Art. GRA 003 mineral grey



Art. GRA 004 verde invernale
Art. GRA 004 winter green



Art. GRA 005 verde vita
Art. GRA 005 life green



Art. GRA 006 rosa fanatico
Art. GRA 006 vain rose



Art. GRA 007 azzurro tramonto
Art. GRA 007 sunset blue



Art. GRA 008 azzurro occhi
Art. GRA 008 blue eyes



Art. GRA 009 rosso terra
Art. GRA 009 earth red



01.

01. freestanding GRAAL in terracotta naturale o smaltato in 8 varianti di colore. Riferimento tabella colori, nelle schede tecniche
 GRAAL freestanding washbasin made of natural earthen or enamelled in 8 different colours. See the colour list in the technical area



02.



03.

02. freestanding GRAAL in terracotta smaltata verde vita / life green GRAAL freestanding washbasin made of enamelled earthen
 03. freestanding GRAAL in terracotta smaltata grigio caldo, grigio minerale e rosa fanatico
 warm grey, mineral grey and vain rose GRAAL freestanding washbasin made of enamelled earthen



04.

04. freestanding GRAAL in terracotta naturale con trattamento antiacqua
 GRAAL freestanding washbasin made of natural earthen with waterproof treatment

TANDEM

design: Paolo Ulian

photographer: Paolo Veclani
interiors e styling: Michele Pasini, Storage

Ancora un premio prestigioso per TANDEM, vincitore già dell'IF e dell'ADI INDEX. AZZURRA Sanitari e Paolo Ulian con il progetto TANDEM, ricevono la Menzione d'Onore al compasso d'Oro 2011. Un riconoscimento unico, che sottolinea il magnifico lavoro di Paolo Ulian, e l'impegno che l'azienda sta portando avanti negli ultimi anni.

Another very prestigious award for TANDEM, still winner of the if and of the ADI INDEX. AZZURRA Sanitari and Paolo Ulian receive the honorary mention to the Golden Compass 2011 for the project TANDEM. A really unique award for its prestigious that stresses the magnificent work of Paolo Ulian and the commitment that AZZURRA is bringing forward during these last years.





lavabo sospeso monoforo Tandem ULI200/1 con cesta portabiancheria in poliuretano ULI CES, vaso e bidet terra Tulip one TUO 100 - TUO 500.
ULI200/1 Tandem wall-hung one-hole washbasin with ULI CES polyurethane laundry basket, TUO 100 - TUO 500 Tulip one floor standing WC and bidet



01.



02.



01.lavabo bianco sospeso monoforo / white wall-hung one-hole washbasin

02.lavabo nero sospeso con rubinetteria a parete / black wall-hung washbasin with wall taps and fittings



01.

01.lavabo sospeso monoforo ULI 200/1 con cesta porta biancheria in poliuretano ULI CES
 ULI 200/1 wall-hung one-hole washbasin with ULI CES polyurethane laundry basket



02.



02.lavabo bianco in appoggio ULI 200/1 su mensola 170 / ULI 200/1 white washbasin sit on 170 shelf



CIVITA

angeletti ruzza design

photographer: Paolo Veciani
photographer: Studio 21

CIVITA è un prodotto interamente realizzato a mano da maestranze locali. Le eventuali imperfezioni dovute alla natura del tufo, rendono ogni lavabo un pezzo unico ed esclusivo.

Civita is an entirely handmade product by local craftsmen. Any imperfection is due to the nature of the tuff, making each washbasin unique and exclusive.



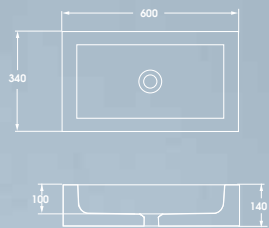

02.



01.

01.lavabo rettangolare CIVITA bianco CIV 60/BCO in tufo con trattamento antispolvero. la vasca interna è trattata con antimacchia e impermeabilizzata.
CIV 60/BCO CIVITA rectangular tuff washbasin with anti-dust treatment. The internal sink is treated with stain-resistant and waterproofed.



03.



04.

02.lavabi tondi CIVITA con vasca interna bianco CIV 44/BCO / CIV 44/BCO CIVITA round washbasins with white internal sink
03.lavabo rettangolare CIVITA con vasca interna rosso CIV 60/RO / CIV 60/RO CIVITA rectangular basin with red internal sink
04.lavabo rettangolare CIVITA con vasca interna blu CIV 60/BLI / CIV 60/BLU CIVITA rectangular basin with blue internal sink





01.

01.lavabo tondo CIVITA con vasca interna bianca CIV 44/BCO / CIV 44/BCO CIVITA round washbasin with snow white internal sink



02.



03.



02.lavabo rettangolare CIVITA con vasca interna blu CIV 60/BLU / CIV 60/BLU CIVITA rectangular basin with blue internal sink
03.lavabo rettangolare CIVITA con vasca interna bianco CIV 60/BCO / CIV 60/BCO CIVITA rectangular basin with white internal sink

NOOK

design: Ilaria Marelli

photographer: Paolo Veclani
interiors e styling: Michele Pasini, Storage





lavabo sospeso NOOK con rubinetteria a parete, vaso e bidet GLAZE sospeso, rubinetteria LINEA
NOOK wall-hung washbasin with wall-mounted tap, GLAZE wall-hung wc and bidet, LINEA taps



01.

01.lavabo NOOK versione bianco / NOOK wall-hung white washbasin



02.



03.



04.



05.

02.lavabo NOOK con rubinetteria monoforo su piano / NOOK wall-hung one-hole washbasin with taps and fittings
 03.lavabo NOOK con rubinetteria a parete / NOOK wall-hung washbasin with wall-mounted taps and fittings
 04.lavabo NOOK con specchio retroilluminato IP44 / NOOK wall-hung washbasin with IP44 backlit mirror
 05.lavabi NOOK versione nero lucido / NOOK wall-hung glossy black washbasin

PIATTI DOCCIA shower tray

FERDY

design: OFFICINA AZZURRA

photographer: Paolo Veciani
photographer: Studio 21



90X90XH6,5



TY90

80X80XH6,5



TY80

90X70XH6,5



TYR9

100X80XH6,5



TYR3

100X70XH6,5



TYR7

120X80XH6,5



TYR1

120X70XH6,5



TYR2

140X80XH6,5



TY 148

140X70XH6,5



TY 147

90X90XH6,5



TY A90

Piatti doccia **ferdy** h. 6,5 cm con possibilità a filo pavimento.
h. 6,5 cm **ferdy** shower trays also available floor level



Trattamento **antibatterico** - **antifungo** applicabile su tutti i prodotti in ceramica e coprivasi.
The treatment **antibacterial** - **antifungal** can be applied to all ceramic products and seat-cover.

90X70XH6 DX



PD R9/AN D

90X70XH6 SX



PD R9/AN S

Piatti doccia **Ferdy** h. 6 cm.
h. 6 cm **Ferdy** shower tray.



02.



03.

02.piatto doccia **Ferdy** 90x70 dx / 120x80 R **Ferdy** shower tray
03.piatto doccia **Ferdy** 90x70 sx /120x80 L **Ferdy** shower tray

solution
design: OFFICINA AZZURRA

photographer: Studio 21



piatto doccia SOLUTION in mineral marmo personalizzabile nelle forme, misure e colori. Completa di piletta doccia sifonata con griglia inox quadra
Solution shower tray made of minerale marble, sizes and colors. Provided with siphoned waste system with square stainless grille.



I piattii doccia SOLUTION sono personalizzabili nelle forme e nelle loro dimensioni per adattarsi perfettamente allo spazio desiderato.
SOLUTION shower trays have customizable shapes and sizes to fit the desired space.

LINEA

angeletti ruzza design

photographer: Paolo Veclani
photographer: Fabrizio Faedda





AZ 1186T gruppo vasca incasso + bocca tonda + doccetta con deviatore
AZ 1186T built-in bath-tub mixer + round spout + shower mixer with diverter



finitura cromo / chrome finishing



AZ1111
lavabo 3 fori tradizionale, bocca ø18
ø18 spout, 3 holes washbasin mixer



AZ1135
bidet monoforo tradizionale, bocca ø18
ø18 spout, one hole bidet mixer



AZ 34
gruppo lavabo 3 fori parete bocca ø18
ø18 spout, 3 holes wall-mounted basin mixer



AZ 745
bidet 3 fori
3 holes bidet mixer



AZ 1186T
gruppo vasca incasso + bocca tonda + doccetta con deviatore / built-in bath-tub mixer + round spout + shower mixer with diverter



AZ 795
doccia esterno termostatico
thermostatic wall-mounted shower mixer



AZ 725
bocca tonda, ø 25mm, lunghezza 210mm
ø 25mm round spout, 210 mm length



AZ 72
rubinetto incasso
built-in mixer



AZ 72
rubinetto incasso
built-in mixer



AZ95
doccetta muro
wall-mounted shower mixer



AZ 718
bocca tonda, ø 18mm, lunghezza 180mm
ø 18mm round spout, 180 mm length



AZ 72
rubinetto arresto
shutoff valve



AZ 72
rubinetto incasso
built-in mixer



AZ 72
rubinetto incasso
built-in mixer



3399
soffione
headshower

collezione LINEA cromo con cartuccia vitone ceramico
LINEA collection with ceramic headvalve cartridge chrome finishing



AZ21
monocomando lavabo
single control washbasin mixer



AZ22
monocomando lavabo bocca prolungata
extended single control washbasin mixer



AZ45
monocomando bidet
single control bidet mixer



AZ L26
lavabo leva clinica
clinical lever washbasin mixer



AZ30
monocomando lavabo bocca alta
high spout single control washbasin mixer



AZ19T
lavabo parete. bocca tonda, 100 mm
100 mm wall-mounted, round spout wash-
basin mixer



AZ19TB
lavabo parete. bocca tonda, 180 mm
180 mm wall-mounted, round spout wash-
basin mixer



AZ23
monocomando lavabo da pavimento
single control floor washbasin mixer

collezione LINEA con cartuccia joystick
LINEA collection with joystick cartridge



AZ P19T
lavabo a parete, bocca tonda, 100 mm
su piastra / 100 mm wall-mounted, round
spout, on plate washbasin mixer



AZ P19TB
lavabo a parete, bocca tonda, 180 mm
su piastra / 180 mm wall-mounted, round
spout, on plate washbasin mixer



AZ P19
lavabo a parete, bocca quadra
wall-mounted, square spout, washbasin
mixer



AZ 795
doccia esterna termostatico
Thermostatic wall-mounted shower mixer



AZ 95
doccetta esterna
wall-mounted shower mixer



AZ 57
gruppo vasca esterno
external bath-tub mixer



3399
soffione
headshower



AZ 60
monocomando vasca freestanding
freestanding single control bath-tub mixer



AZ 83A
miscelatore incasso, placca 65 mm
65 mm plate built-in mixer



AZ 83
doccia incasso, placca 145 mm
145 mm plate, inset shower mixer



AZ 94
doccia incasso, con deviatore, placca 145 mm
145 mm plate built-in shower mixer with diverter

collezione LINEA con cartuccia joystick
LINEA collection with joystick cartridge



AN 21
monocomando lavabo
single control washbasin mixer



AN 22
monocomando lavabo bocca prolungata
extended single control washbasin mixer



AN 45
monocomando bidet
single control bidet mixer



AZ L26
monocomando leva clinica
clinical lever washbasin mixer



AN 30
monocomando lavabo bocca alta
high spout single control washbasin mixer



AN 19T
lavabo a parete, bocca tonda 100 mm
100 mm wall-mounted, round spout



AN 19TB
lavabo a parete, bocca tonda 180 mm
180 mm wall-mounted, round spout



AN 23
monocomando lavabo da pavimento
single control floor washbasin mixer

collezione LINEA con cartuccia ø25 mm
LINEA collection with ø25 mm cartridge



AN P19
lavabo a parete, bocca quadra
wall-mounted, square spout, washbasin
mixer



AN P19T
lavabo a parete, bocca tonda 100 mm
100 mm wall-mounted, round spout, wash-
basin mixer



AN P19TB
lavabo a parete, bocca tonda 180 mm
180 mm wall-mounted, round spout, wash-
basin mixer



AZ 795
doccia esterno termostatico
thermostatic wall-mounted shower mixer



AZ95
doccetta esterna
wall-mounted shower mixer



AN 57
gruppo vasca esterno
external bath-tub mixer



3399
soffione
headshower



AN 60
monocomando vasca freestanding
freestanding single control bath-tub mixer



AN 83A
miscelatore incasso placca 65 mm
65 mm plate built-in mixer



AN 83
doccia incasso placca 145 mm
145 mm plate, inset shower mixer



AN 94
doccia incasso, con deviatore, placca 145 mm
145 mm plate built-in shower mixer with
diverter

collezione LINEA con cartuccia ø25 mm
LINEA collection with ø25 mm cartridge

